



# **HRV D(R) / ERV D(R)** **HRV EC D(R) / ERV EC D(R)**





**Heat and Energy Recovery Ventilation**



# CONTENTS

<b>OVERVIEW</b>	<b>2</b>
<b>HRV D(R) / ERV D(R) SERIES</b>	
ERV D(R) 80	4
HRV D(R) 120 / ERV D(R) 120	8
HRV D(R) 150 / ERV D(R) 150	14
<b>HRV EC D(R) / ERV EC D(R) SERIES</b>	
ERV EC D(R) 80	20
HRV EC D(R) 120 / ERV EC D(R) 120	24
HRV EC D(R) 150 / ERV EC D(R) 150	30
<b>ACCESSORIES</b>	
S52	36
CD-1 / CD-2	37
HR-S	38
CDP-2/5	39
AC208EM2+LP	40

# HRV D(R) / ERV D(R) Series Overview

	ERV D 80	ERV DR 80	ERV EC D 80	ERV EC DR 80	ERV D 120	ERV DR 120	ERV EC D 120	ERV EC DR 120
								
Core								
Motor	AC	EC	AC	EC	AC	EC	AC	EC
Airflow @ 0.1 in. W. G.	85 CFM	93 CFM	81 CFM	81 CFM	127 CFM	136 CFM	161 CFM	150 CFM
Max. CFM/W	-	-	1.72	1.72	0.96	1.94	0.25	0.25
Sensible Recovery Efficiency at 32 °F (0 °C)	64 %	65 %	73 %	73 %	67 %	68 %	71 %	72 %
Defrost system	Fan defrost	Recirculation	Fan defrost	Recirculation	Fan defrost	Recirculation	Fan defrost	Recirculation
Built-in control board with independent fan speed adjustment 0 %-100 %	+	+	+	+	+	+	+	+
Slim casing design	8 7/16"				9 1/16"			

	HRV D 120	HRV DR 120	HRV EC D 120	HRV EC DR 120	ERV D 150	ERV DR 150	ERV EC D 150	ERV EC DR 150	HRV D 150	HRV DR 150	HRV EC D 150	HRV EC DR 150
Core												
Motor	AC	EC	AC	EC	AC	EC	AC	EC	AC	EC	AC	EC
Airflow @ 0.1 in. W. G.	142 CFM	189 CFM	178 CFM	181 CFM	161 CFM	186 CFM						
Max. CFM/W	0.84	2.86	-	2.56	0.78	2.56						
Sensible Recovery Efficiency at 32 °F (0 °C)	60	62	66	73	64	69						
Defrost system	Fan defrost	Recirculation	Fan defrost	Recirculation	Fan defrost	Recirculation	Fan defrost	Recirculation	Fan defrost	Recirculation	Fan defrost	Recirculation
Built-in control board with independent fan speed adjustment 0 %-100 %	+	+	+	+	+	+	+	+	+	+	+	+
Slim casing design	9 1/16"				9 1/8"							

# ERV D(R) 80

## Energy Recovery Ventilator

Energy Recovery Ventilators are the complete whole house ventilation system designed to bring a continuous supply of fresh air into the house while exhausting an equal amount of stale air



HRV D(R) / ERV D(R) SERIES

### Description

- 93 CFM airflow rate provides effective ventilation in apartment overcoming high pressure in condo tower duct systems.
- Cross flow core ensures up to 65 % SRE.
- Slim casing design (8 7/16") is perfect for in-ceiling installation.
- built-in control board enables Supply and Exhaust fan independent speed adjustment from 0 to 100 % right at the job side.
- Fast and simple mounting process thanks to brackets system.
- Automatic recirculation damper (R option) for effective cold protection.
- No drain needed (ERV).

### Casing

- Steel casing is covered with high-quality multilayer aluminum and zinc alloy to prevent corrosion.
- The casing is equipped with a switch to turn the ventilator off when the service panel is opened.

### Filter

- Washable MERV 6 air filters in exhaust and supply air streams.
- Optional supply: anti grease aluminum filter.

### Fans

- The unit is equipped with supply and exhaust centrifugal fans with backward curved blades and built-in thermal overheating protection with automatic restart. The electric motors and impellers are dynamically balanced.

### Energy Recovery Core

- Enthalpic core provides both heat&humidity recovery. For enthalpic core no drain required.



### Defrost System

- Defrost system is activated when the outdoor temperature falls below 23 °F.
- Recirculation defrost ERV DR 80.
- Fan stop defrost ERV D 80.

### Constant Flow

- ERV D(R) 80 CF has an automatic constant air flow control function to keep the air flow in supply and exhaust air ducts constant even in case of variable air resistance.
- This function is provided with the integrated air flow control units. The electronic sensors convert the actual air flow to the analogue signal that is proportional to the air flow in the air duct. These signals are transmitted to the controller that controls the rotation speed of a respective fan in such a way that the actual rotations speed is equal to the set value.









### Manual Balancing

- Manual balancing is a standard balancing system. Fan speed manually adjusted by operating on units controller (built-in control board with independent fan speed adjustment 0 %-100 %).

### Control

- The unit incorporates an integrated automation and control system with following functions:
  - Operation mode switch.
  - Air flow balancing enabled by supply and exhaust fan independent speed adjustment from 0 to 100 % (percentage is displayed on built-in screen).
  - Automatic recovery core frost protection.
  - External control device connection (up to 5 at the same time).

#### Accessories

Backdraft Dampers	Air Disk Valves	Clamps	Push Button Timer	CO <sub>2</sub> Sensors	Humidistat	Wall Speed Controller	Wall Control Panel
							
VRV	VPR	K	S52	CD-1	CD-2	HR-S	CDP-2/5 AC208EM2+LP

**Mounting**

- Due to low height of the casing the units offer perfect solution for the false ceiling installation in limited space.
- Brackets system makes mounting process easy and fast.



Step 1

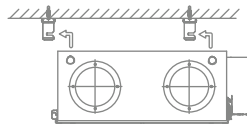

Step 2

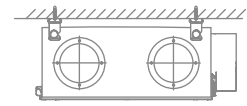

Step 3

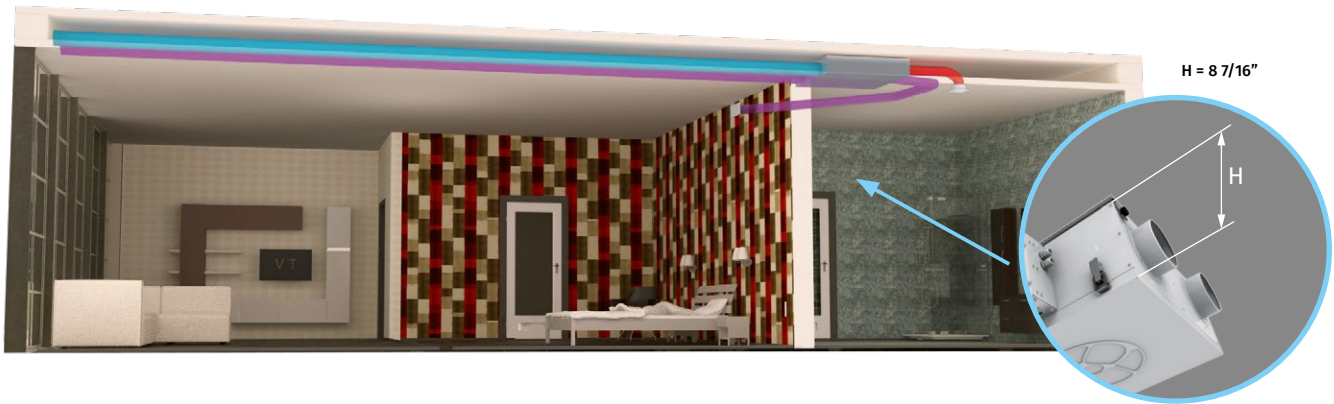

**Dimensions**

**ERV D 80**

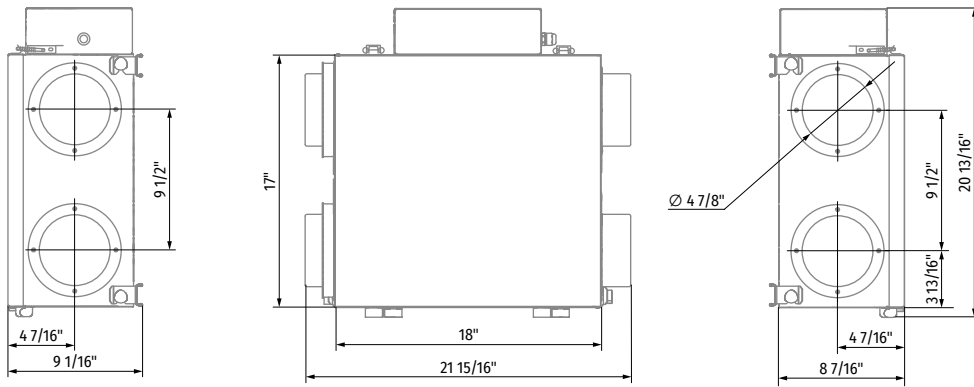

**ERV DR 80**

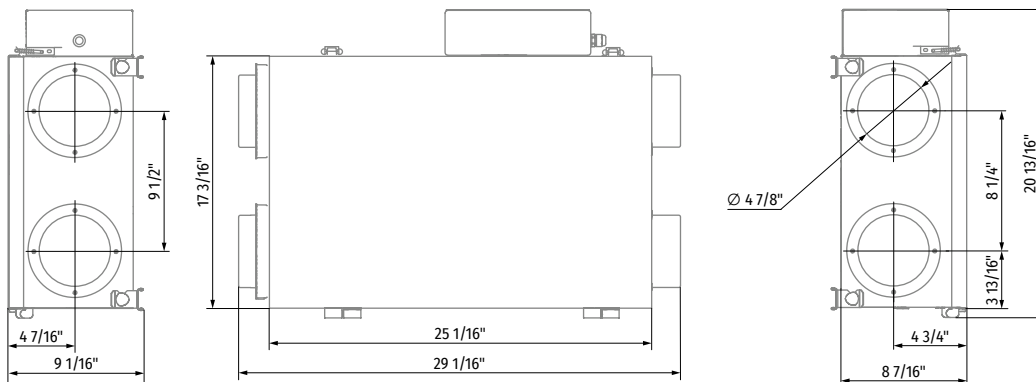

**Technical Data**

**ERV D 80**

External Static Pressure		Net Supply Air Flow		Gross Air Flow				Power
Pa	in WG	l/s	CFM	Supply		Exhaust		Watts
				l/s	CFM	l/s	CFM	
25	0.1	40	85	41	87	39	83	72
50	0.2	36	76	36	76	34	72	72
75	0.3	31	66	31	66	28	59	72
100	0.4	25	53	26	55	22	47	71
125	0.5	20	42	20	42	17	36	70

Note: fan curve performed on high speed

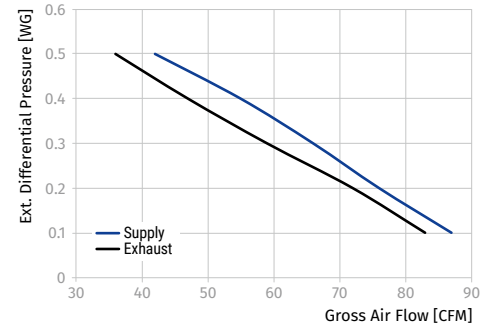

Temp Mode	Supply Temp [°C]	Supply Temp [°F]	Net Air Flow [l/s]	Net Air Flow [CFM]	Watts	SRE	ASRE	Latent Recovery / Moisture Transfer	TRE	ATRE
Heating	0	32	20	43	38	64	70	0.36		
	0	32	24	51	42	64	70	0.33		
	0	32	28	59	48	63	68	0.31		
Cooling	35	95	20	43	40			0.36	39	43
	35	95	24	51	48			0.32	37	40



Model	Volts	Max. Watts	Max. Amps
ERV D 80	120 V, 60 Hz	72	0.6

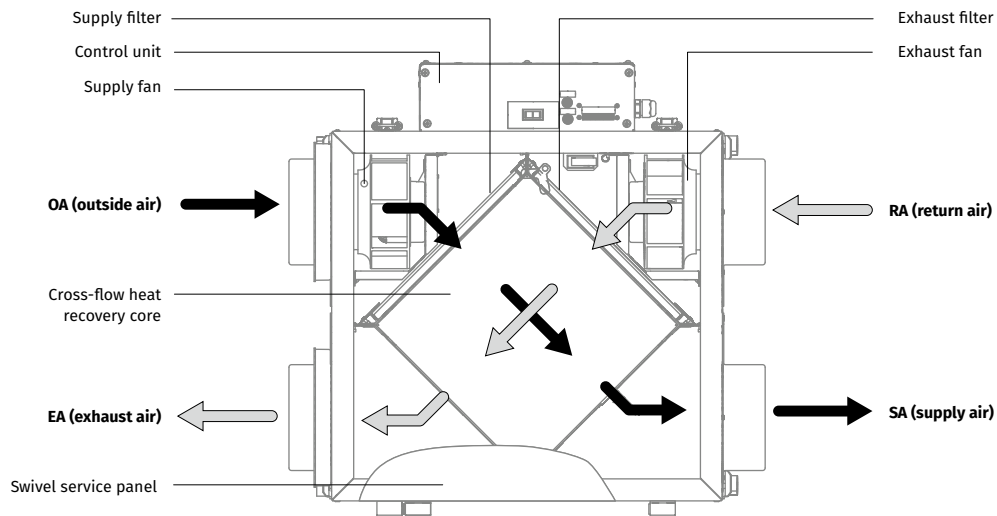

HRV D(R) / ERV D(R) SERIES



**ERV DR 80**

External Static Pressure		Net Supply Air Flow		Gross Air Flow				Power
Pa	in WG	l/s	CFM	Supply		Exhaust		Watts
				l/s	CFM	l/s	CFM	
25	0.1	44	93	47	100	41	87	69
50	0.2	39	83	42	89	35	74	69
75	0.3	34	72	36	76	29	61	68
100	0.4	29	61	31	66	23	49	67

Note: fan curve performed on high speed

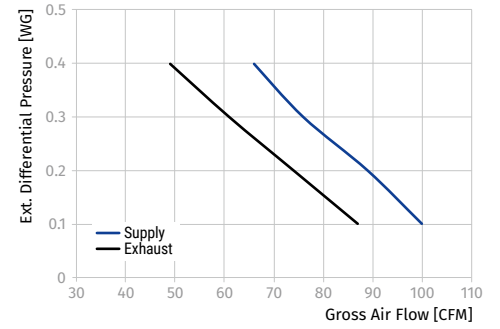

Temp Mode	Supply Temp [°C]	Supply Temp [°F]	Net Air Flow [l/s]	Net Air Flow [CFM]	Watts	SRE	ASRE	Latent Recovery / Moisture Transfer	TRE	ATRE	VLTVR Supply	VLTVR Exhaust	Very Low Temp Air Flow Imbalance
Heating	0	32	19	40	40	65	72	0.52					
	0	32	22	47	46	63	69	0.53					
Cooling	-25	-13	24	51	64	41	43	0.34			8	42.6	144
	35	95	23	49	50			0.43	45	50			



Model	Volts	Max. Watts	Max. Amps
ERV DR 80	120 V, 60 Hz	69	0.6

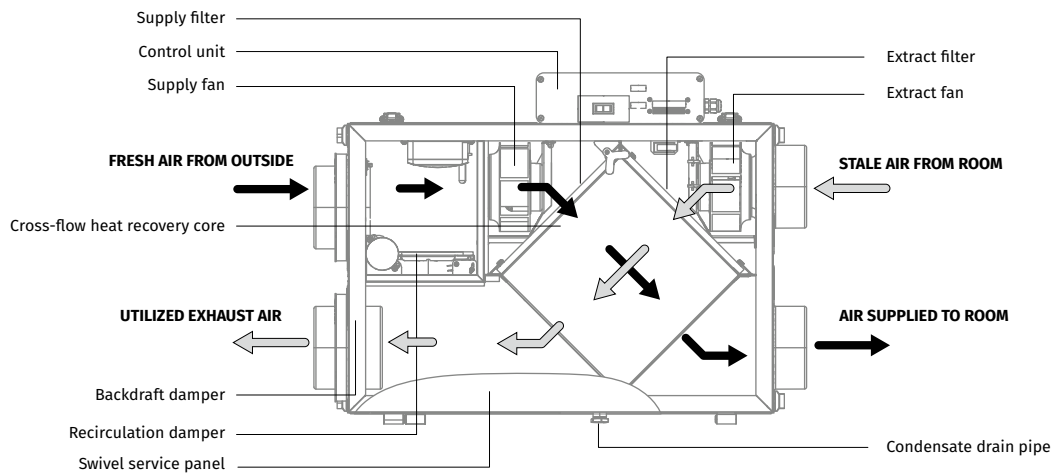

HRV D(R) / ERV D(R) SERIES

# HRV D(R) 120 / ERV D(R) 120

## Heat and Energy Recovery Ventilators

Heat and Energy Recovery Ventilators are the complete whole house ventilation system designed to bring a continuous supply of fresh air into the house while exhausting an equal amount of stale air.



HRV D(R) / ERV D(R) SERIES

### Description

- 142 CFM airflow rate provides effective ventilation in apartment overcoming high pressure in condo tower duct systems.
- Cross flow core ensures up to 68 % SRE.
- Slim casing design (9 1/16") is perfect for in-ceiling installation.
- built-in control board enables Supply and Exhaust fan independent speed adjustment from 0 to 100 % right at the job side.
- Fast and simple mounting process thanks to brackets system.
- Automatic recirculation damper (R option) for effective cold protection.
- No drain needed (ERV).

### Casing

- Steel casing is covered with high-quality multilayer aluminium and zinc alloy to prevent corrosion.
- The casing is equipped with a switch to turn the ventilator off when the service panel is opened.

### Filter

- Washable MERV 6 air filters in exhaust and supply air streams.
- Optional supply: anti grease aluminum filter.

### Fans

- The unit is equipped with supply and exhaust centrifugal fans with forward curved blades and built-in thermal overheating protection with automatic restart. The electric motors and impellers are dynamically balanced.

### Defrost System

- Defrost system is activated when the outdoor temperature falls below 23 °F.
- Recirculation defrost HRV/ERV DR 120.
- Fan stop defrost HRV/ERV D 120.

### Manual Balancing

- Manual balancing is a standard balancing system. Fan speed manually adjusted by operating on units controller (built-in control board with independent fan speed adjustment 0 %-100 %).

### Heat and Energy Recovery Core

#### HEAT RECOVERY CORE

- Polystyrene core (**HRV D(R) 120**) ensures efficient heat recovery.

#### ENERGY RECOVERY CORE

- Enthalpic core (**ERV D(R) 120**) provides both heat&humidity recovery. For enthalpic core no drain required.

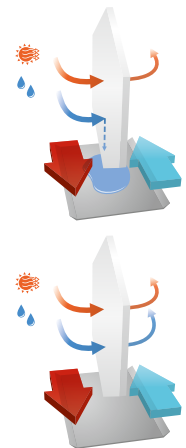

### Constant Flow

- HRV D(R) 120 CF, ERV D(R) 120 CF has an automatic constant air flow control function to keep the air flow in supply and exhaust air ducts constant even in case of variable air resistance.
- This function is provided with the integrated air flow control units. The electronic sensors convert the actual air flow to the analogue signal that is proportional to the air flow in the air duct. These signals are transmitted to the controller that controls the rotation speed of a respective fan in such a way that the actual rotations speed is equal to the set value.

### Control

- The unit incorporates an integrated automation and control system with following functions:
  - Operation mode switch.
  - Air flow balancing enabled by supply and exhaust fan independent speed adjustment from 0 to 100 % (percentage is displayed on built-in screen).
  - Automatic recovery core frost protection.
  - External control device connection (up to 5 at the same time).

#### Accessories

Backdraft Dampers	Air Disk Valves	Clamps	Push Button Timer	CO <sub>2</sub> Sensors	Humidistat	Wall Speed Controller	Wall Control Panel
VRV	VPR	K	S52	CD-1	CD-2	HR-S	CDP-2/5
							AC208EM2+LP

**Mounting**

- Due to low height of the casing the units offer perfect solution for the false ceiling installation in limited space.
- Brackets system makes mounting process easy and fast.



Step 1

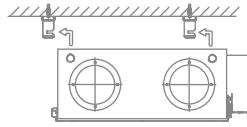

Step 2

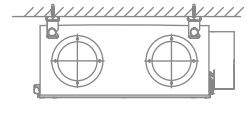

Step 3

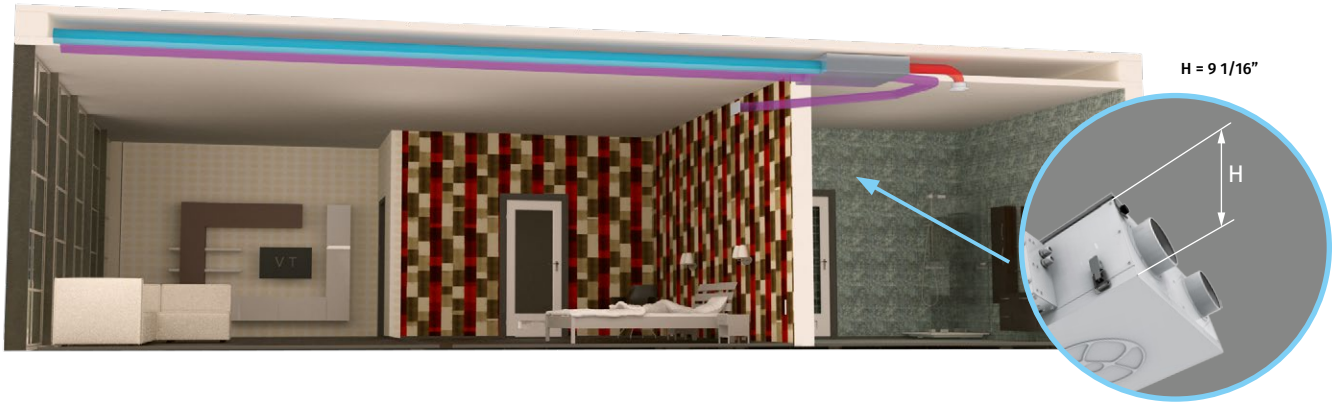

**Dimensions**

**HRV D 120 / ERV D 120**

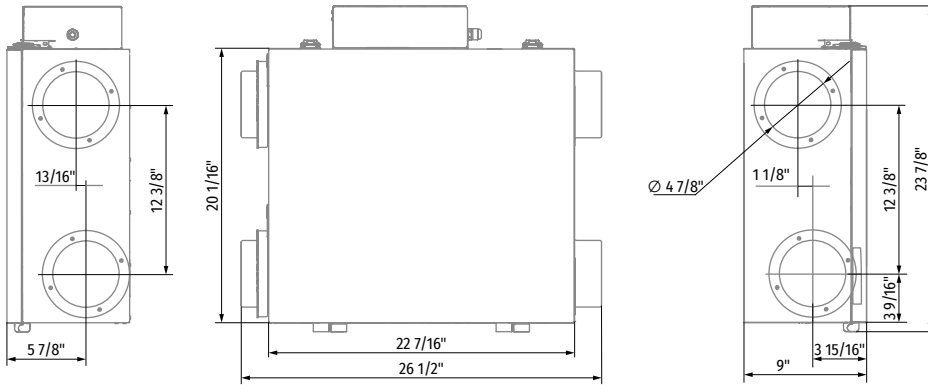

**HRV DR 120 / ERV DR 120**

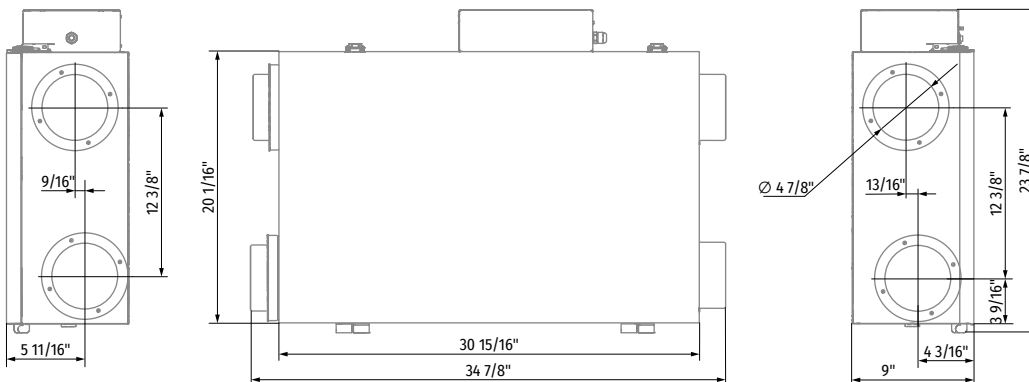

**Technical Data**

**HRV D 120**

External Static Pressure		Net Supply Air Flow		Gross Air Flow				Power
Pa	in WG	l/s	CFM	Supply		Exhaust		Watts
				l/s	CFM	l/s	CFM	
25	0.1	67	142	69	146	64	136	158
50	0.2	65	138	67	142	62	131	157
75	0.3	63	134	65	138	60	127	156
100	0.4	62	132	64	136	58	123	155
125	0.5	60	127	62	131	56	119	153
150	0.6	58	123	60	127	54	114	152
175	0.7	56	119	58	123	52	110	151
200	0.8	53	113	55	117	50	106	149
225	0.9	51	109	53	112	47	100	148
250	1	48	101	49	104	44	93	146
275	1.1	44	92	45	95	40	85	143
300	1.2	40	84	41	87	34	72	141
325	1.3	30	64	31	66	26	55	135
350	1.4	17	37	18	38	15	32	130
375	1.5	10	21	10	21	8	17	128

Note: fan curve performed on high speed

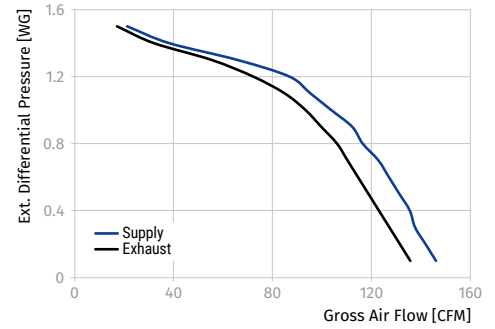

		Supply Temperature		Net Air Flow		Average Power [Watts]	Sensible Recovery Efficiency	Apparent Sensible Effectiveness	Net Moisture Transfer
		°C	°F	l/s	CFM				
Heating	I	0	32	30	64	86	60	70	0.05
	II	0	32	45	95	114	57	67	0.04
	III	0	32	50	106	126	55	65	0.04
**Total Recovery Efficiency									
Cooling	VI	35	95	30	64	86	29**	61	0.04

Model	Volts	Max. Watts	Max. Amps
HRV D 120	120 V, 60 Hz	158	1.3

\*\* Indicates total recovery efficiency, not sensible recovery efficiency 250 Pa = 1 in of water: 0.472 l/s = 1 CFM

HRV D(R) / ERV D(R) SERIES

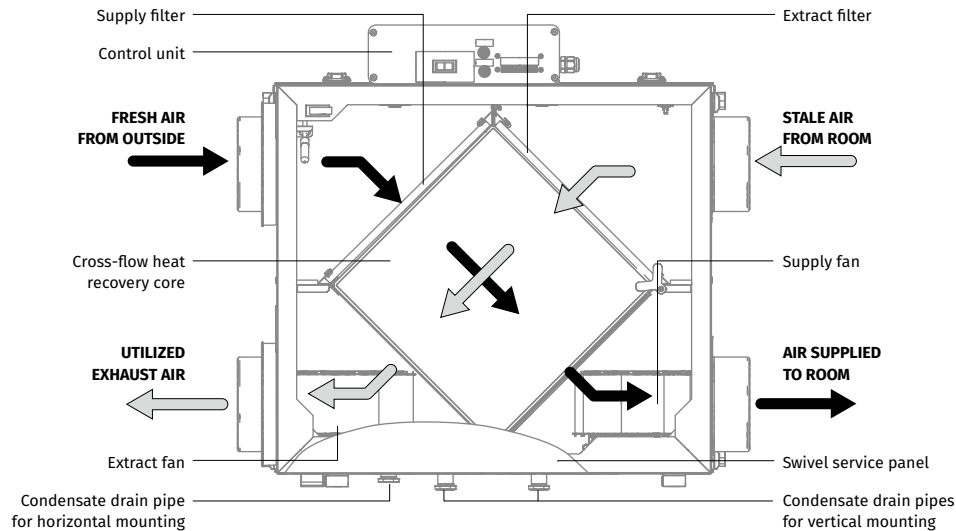

**ERV D 120**

External Static Pressure		Net Supply Air Flow		Gross Air Flow				Power
Pa	in WG	l/s	CFM	Supply		Exhaust		Watts
				l/s	CFM	l/s	CFM	
25	0.1	60	127	61	129	61	129	139
50	0.2	58	123	59	125	59	125	135
75	0.3	56	119	57	121	57	121	135
100	0.4	54	114	55	117	55	117	132
125	0.5	52	110	53	112	53	112	129
150	0.6	50	106	52	110	51	108	128
175	0.7	48	102	49	104	49	104	124
200	0.8	46	97	47	100	47	100	121
225	0.9	43	91	44	93	44	93	118
250	1	40	85	40	85	41	87	114

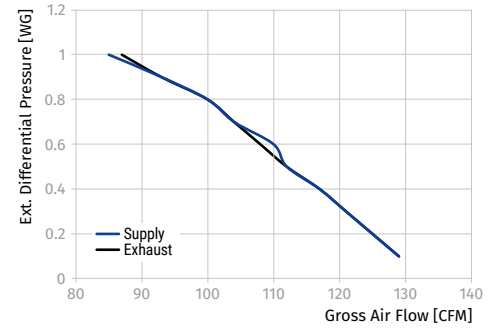

Note: fan curve performed on high speed

Temp Mode	Supply Temp [°C]	Supply Temp [°F]	Net Air Flow [l/s]	Net Air Flow [CFM]	Watts	SRE	ASRE	Latent Recovery / Moisture Transfer	TRE	ATRE	VLTVR Supply	VLTVR Exhaust	Very Low Temp Air Flow Imbalance
Heating	0	32	24	51	64	67	75	0.64					
Cooling	35	95	24	51	64			0.50	48	53			



Model	Volts	Max. Watts	Max. Amps
ERV D 120	120 V, 60 Hz	139	1.3

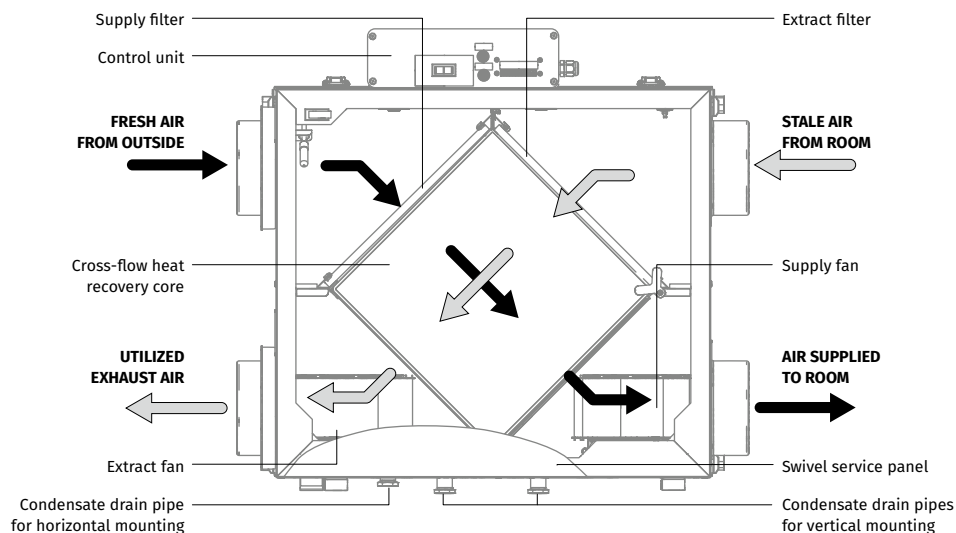

HRV D(R) / ERV D(R) SERIES

**HRV DR 120**

External Static Pressure		Net Supply Air Flow		Gross Air Flow				Power
Pa	in WG	l/s	CFM	Supply		Exhaust		Watts
				l/s	CFM	l/s	CFM	
25	0.1	67	142	69	146	64	136	158
50	0.2	65	138	67	142	62	131	157
75	0.3	63	134	65	138	60	127	156
100	0.4	62	132	64	136	58	123	155
125	0.5	60	127	62	131	56	119	153
150	0.6	58	123	60	127	54	114	152
175	0.7	56	119	58	123	52	110	151
200	0.8	53	113	55	117	50	106	149
225	0.9	51	109	53	112	47	100	148
250	1	48	101	49	104	44	93	146
275	1.1	44	92	45	95	40	85	143
300	1.2	40	84	41	87	34	72	141
325	1.3	30	64	31	66	26	55	135
350	1.4	17	37	18	38	15	32	130
375	1.5	10	21	10	21	8	17	128

Note: fan curve performed on high speed

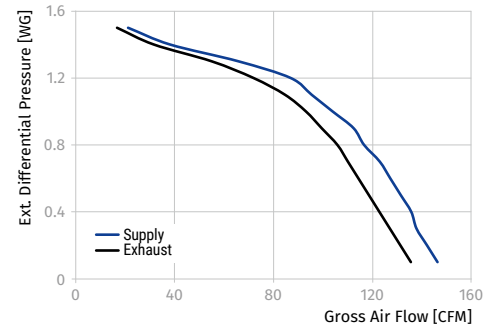

		Supply Temperature		Net Air Flow		Average Power [Watts]	Sensible Recovery Efficiency	Apparent Sensible Effectiveness	Net Moisture Transfer
		°C	°F	l/s	CFM				
Heating	I	0	32	30	64	86	60	70	0.05
	II	0	32	45	95	114	57	67	0.04
	III	0	32	50	106	126	55	65	0.04
	IV	-25	-13	25	54	97	50	79	0.46
	**Total Recovery Efficiency								
Cooling	VI	35	95	30	64	86	29**	61	0.04

\*\* Indicates total recovery efficiency, not sensible recovery efficiency 250 Pa = 1 in of water: 0.472 l/s = 1 CFM

Model	Volts	Max. Watts	Max. Amps
HRV DR 120	120 V, 60 Hz	158	1.3

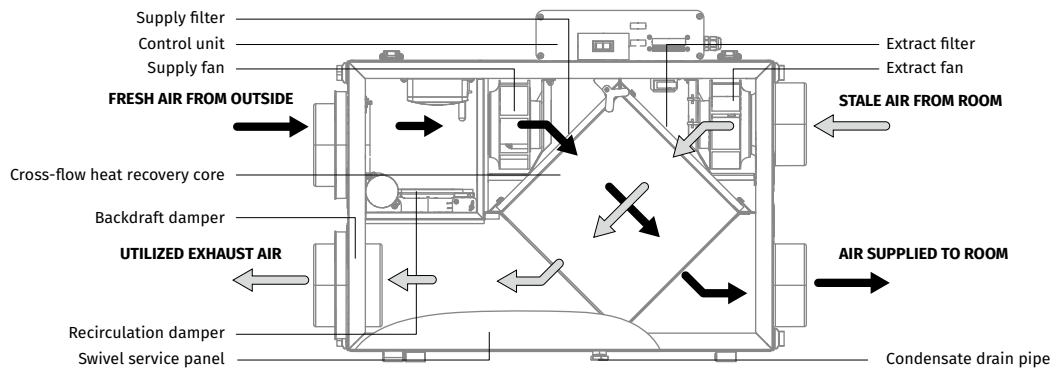

HRV D(R) / ERV D(R) SERIES

**ERV DR 120**

External Static Pressure		Net Supply Air Flow		Gross Air Flow				Power
Pa	in WG	l/s	CFM	Supply		Exhaust		Watts
				l/s	CFM	l/s	CFM	
25	0.1	64	136	65	138	66	140	143
50	0.2	62	131	63	133	63	133	140
75	0.3	59	125	61	129	60	127	136
100	0.4	57	121	59	125	58	123	133
125	0.5	55	117	57	121	56	119	130
150	0.6	53	112	54	114	53	112	127
175	0.7	51	108	52	110	50	106	125
200	0.8	49	104	50	106	48	102	122
225	0.9	46	97	47	100	45	95	118
250	1	43	91	44	93	41	87	114

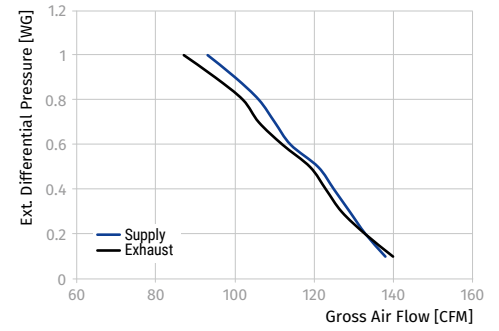

Note: fan curve performed on high speed

Temp Mode	Supply Temp [°C]	Supply Temp [°F]	Net Air Flow [l/s]	Net Air Flow [CFM]	Watts	SRE	ASRE	Latent Recovery / Moisture Transfer	TRE	ATRE	VLTVR Supply	VLTVR Exhaust	Very Low Temp Air Flow Imbalance
Heating	0	32	24	51	64	68	76	0.66					
	-25	-13	25	51	97	50	54	0.46			29.3	15.2	84
Cooling	35	95	24	51	62			0.54	51	56			



Model	Volts	Max. Watts	Max. Amps
ERV DR 120	120 V, 60 Hz	143	1.3

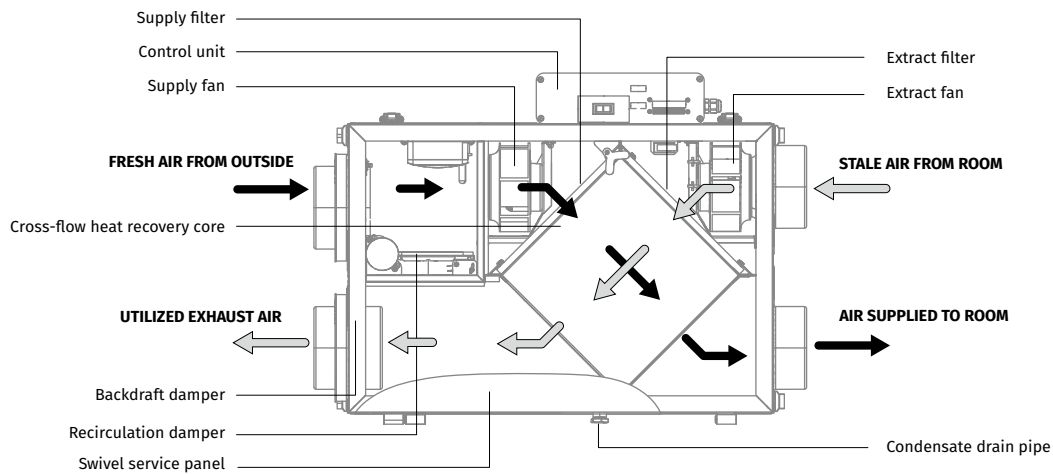

HRV D(R) / ERV D(R) SERIES

# HRV D(R) 150 / ERV D(R) 150

## Heat and Energy Recovery Ventilators

Heat and Energy Recovery Ventilators are the complete whole house ventilation system designed to bring a continuous supply of fresh air into the house while exhausting an equal amount of stale air.



HRV D(R) / ERV D(R) SERIES

### Description

- 178 CFM airflow rate provides effective ventilation in apartment overcoming high pressure in condo tower duct systems.
- Cross flow core ensures up to 66 % SRE.
- Slim casing design (9 1/8") is perfect for in-ceiling installation.
- built-in control board enables Supply and Exhaust fan independent speed adjustment from 0 to 100 % right at the job side.
- Fast and simple mounting process thanks to brackets system.
- Automatic recirculation damper (R option) for effective cold protection.
- No drain needed (ERV).

### Casing

- Steel casing is covered with high-quality multilayer aluminium and zinc alloy to prevent corrosion.
- The casing is equipped with a switch to turn the ventilator off when the service panel is opened.

### Filter

- Washable MERV 6 air filters in exhaust and supply air streams.
- Optional supply: anti grease aluminum filter.

### Fans

- The unit is equipped with supply and exhaust centrifugal fans with backward curved blades and built-in thermal overheating protection with automatic restart. The electric motors and impellers are dynamically balanced.

### Defrost System

- Defrost system is activated when the outdoor temperature falls below 23 °F.
- Recirculation defrost HRV/ERV DR 150.
- Fan stop defrost HRV/ERV D 150.

### Manual Balancing

- Manual balancing is a standard balancing system. Fan speed manually adjusted by operating on units controller (built-in control board with independent fan speed adjustment 0 %-100 %).

### Heat and Energy Recovery Core

#### HEAT RECOVERY CORE

- Polystyrene core (**HRV D(R) 150**) ensures efficient heat recovery.



#### ENERGY RECOVERY CORE

- Enthalpic core (**ERV D(R) 150**) provides both heat&humidity recovery. For enthalpic core no drain required.











### Constant Flow

- HRV D(R) 150 CF, ERV D(R) 150 CF has an automatic constant air flow control function to keep the air flow in supply and exhaust air ducts constant even in case of variable air resistance.
- This function is provided with the integrated air flow control units. The electronic sensors convert the actual air flow to the analogue signal that is proportional to the air flow in the air duct. These signals are transmitted to the controller that controls the rotation speed of a respective fan in such a way that the actual rotations speed is equal to the set value.

### Control

- The unit incorporates an integrated automation and control system with following functions:
  - Operation mode switch.
  - Air flow balancing enabled by supply and exhaust fan independent speed adjustment from 0 to 100 % (percentage is displayed on built-in screen).
  - Automatic recovery core frost protection.
  - External control device connection (up to 5 at the same time).

#### Accessories

Backdraft Dampers	Air Disk Valves	Clamps	Push Button Timer	CO <sub>2</sub> Sensors	Humidistat	Wall Speed Controller	Wall Control Panel
							
VRV	VPR	K	S52	CD-1	CD-2	HR-S	CDP-2/5
							AC208EM2+LP



**Mounting**

- Due to low height of the casing the units offer perfect solution for the false ceiling installation in limited space.
- Brackets system makes mounting process easy and fast.



Step 1

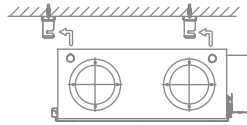

Step 2

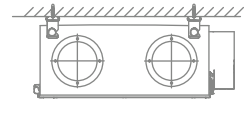

Step 3

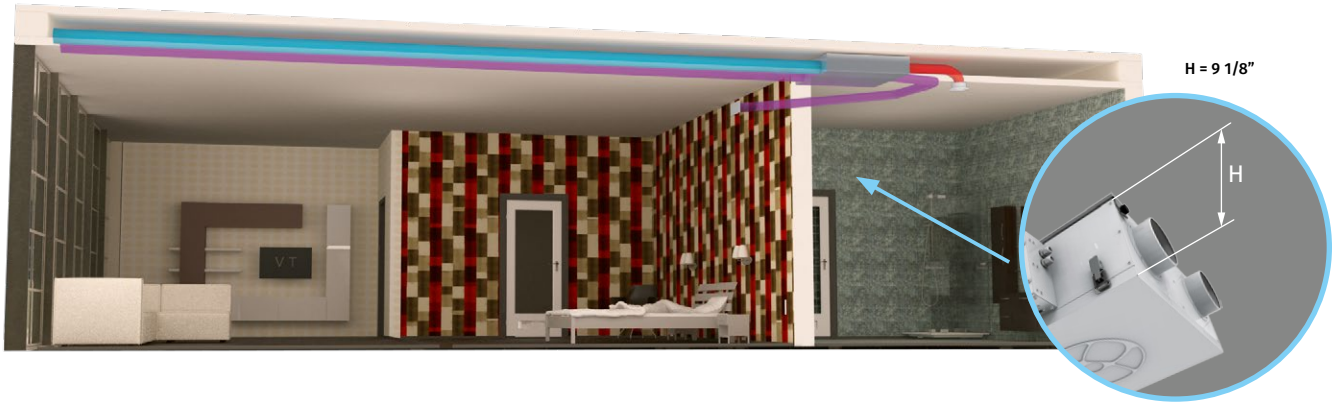

**Dimensions**

**HRV D 150 / ERV D 150**

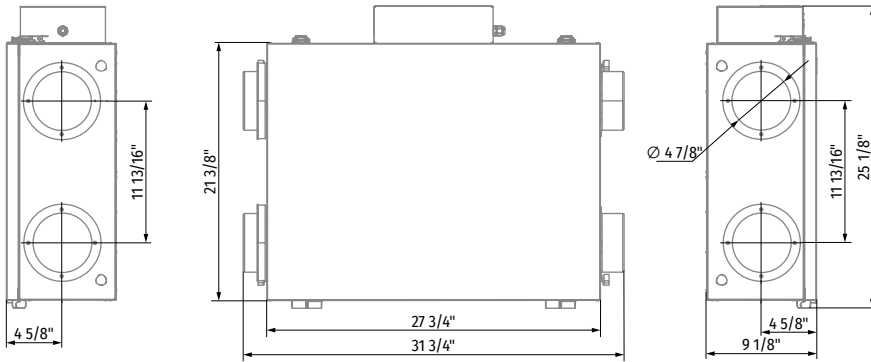

**HRV DR 150 / ERV DR 150**

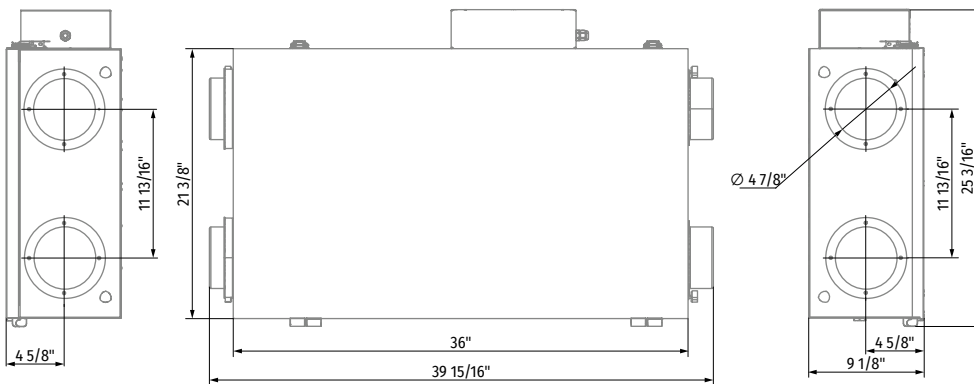

**Technical Data**

**HRV D 150**

External Static Pressure		Net Supply Air Flow		Gross Air Flow				Power
Pa	in WG	l/s	CFM	Supply		Exhaust		Watts
				l/s	CFM	l/s	CFM	
25	0.1	76	161	79	166	71	149	192
50	0.2	73	154	75	159	67	142	192
75	0.3	68	145	71	149	64	135	191
100	0.4	65	137	67	141	60	127	191
125	0.5	60	127	62	131	56	119	191
150	0.6	56	119	58	123	52	110	190
175	0.7	52	110	54	113	48	102	189
200	0.8	48	101	49	104	44	93	188
225	0.9	38	81	44	93	40	84	187
250	1	34	72	39	83	35	74	186

Note: fan curve performed on high speed

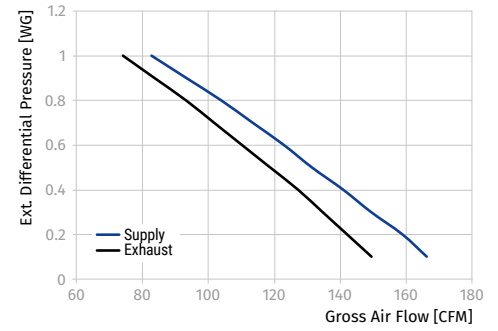

		Supply Temperature		Net Air Flow		Average Power [Watts]	Sensible Recovery Efficiency	Apparent Sensible Effectiveness	Net Moisture Transfer
		°C	°F	l/s	CFM				
Heating	I	0	32	31	65	97	64	79	0.05
	II	0	32	44	94	124	62	76	0.05
	III	0	32	49	104	134	60	74	0.05
	IV								
	V	-25	-13						
**Total Recovery Efficiency									
Cooling	VI	35	95	30	64	97	31.1**	64	0.04

\*\* Indicates total recovery efficiency, not sensible recovery efficiency 250 Pa = 1 in of water: 0.472 l/s = 1 CFM

Model	Volts	Max. Watts	Max. Amps
HRV D 150	120 V, 60 Hz	192	1.6

HRV D(R) / ERV D(R) SERIES

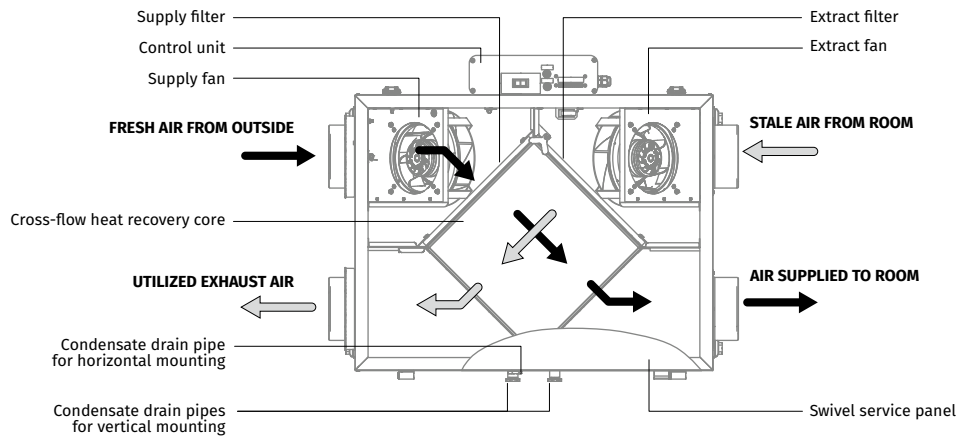

**ERV D 150**

External Static Pressure		Net Supply Air Flow		Gross Air Flow				Power
Pa	in WG	l/s	CFM	Supply		Exhaust		Watts
				l/s	CFM	l/s	CFM	
25	0.1	84	178	85	180	83	176	189
50	0.2	79	167	80	170	79	167	189
75	0.3	75	159	76	161	74	157	186
100	0.4	71	150	72	153	69	146	185
125	0.5	67	142	67	142	64	136	183
150	0.6	62	131	63	133	60	127	181
175	0.7	58	123	58	123	55	117	179
200	0.8	53	112	53	112	50	106	176
225	0.9	48	102	49	104	46	97	174
250	1	43	91	43	91	41	87	171

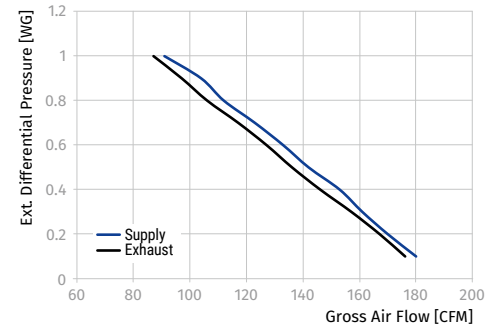

Note: fan curve performed on high speed

Temp Mode	Supply Temp [°C]	Supply Temp [°F]	Net Air Flow [l/s]	Net Air Flow [CFM]	Watts	SRE	ASRE	Latent Recovery / Moisture Transfer	TRE	ATRE
Heating	0	32	31	66	102	66	76	0.50		
	0	32	46	97	130	63	72	0.50		
	0	32	50	106	138	63	71	0.41		
Cooling	35	95	31	66	100			0.34	39	44
	35	95	46	97	132			0.31	35	40



Model	Volts	Max. Watts	Max. Amps
ERV D 150	120 V, 60 Hz	189	1.6

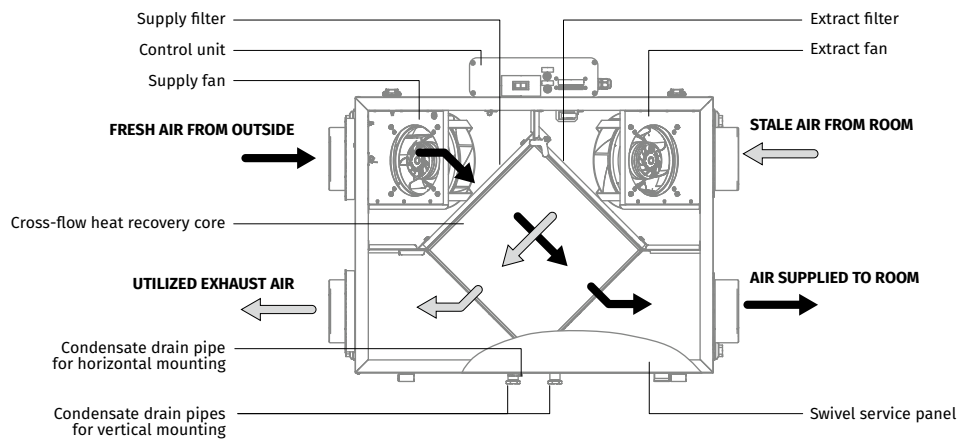

HRV D(R) / ERV D(R) SERIES

**HRV DR 150**

External Static Pressure		Net Supply Air Flow		Gross Air Flow				Power
Pa	in WG	l/s	CFM	Supply		Exhaust		Watts
				l/s	CFM	l/s	CFM	
25	0.1	76	161	79	166	71	149	192
50	0.2	73	154	75	159	67	142	192
75	0.3	68	145	71	149	64	135	191
100	0.4	65	137	67	141	60	127	191
125	0.5	60	127	62	131	56	119	191
150	0.6	56	119	58	123	52	110	190
175	0.7	52	110	54	113	48	102	189
200	0.8	48	101	49	104	44	93	188
225	0.9	38	81	44	93	40	84	187
250	1	34	72	39	83	35	74	186

Note: fan curve performed on high speed



		Supply Temperature		Net Air Flow		Average Power [Watts]	Sensible Recovery Efficiency	Apparent Sensible Effectiveness	Net Moisture Transfer
		°C	°F	l/s	CFM				
Heating	I	0	32	31	65	97	64	79	0.05
	II	0	32	44	94	124	62	76	0.05
	III	0	32	49	104	134	60	74	0.05
	IV								
	V	-25	-13						
**Total Recovery Efficiency									
Cooling	VI	35	95	30	64	97	31.1**	64	0.04

\*\* Indicates total recovery efficiency, not sensible recovery efficiency 250 Pa = 1 in of water: 0.472 l/s = 1 CFM

Model	Volts	Max. Watts	Max. Amps
HRV DR 150	120 V, 60 Hz	192	1.6

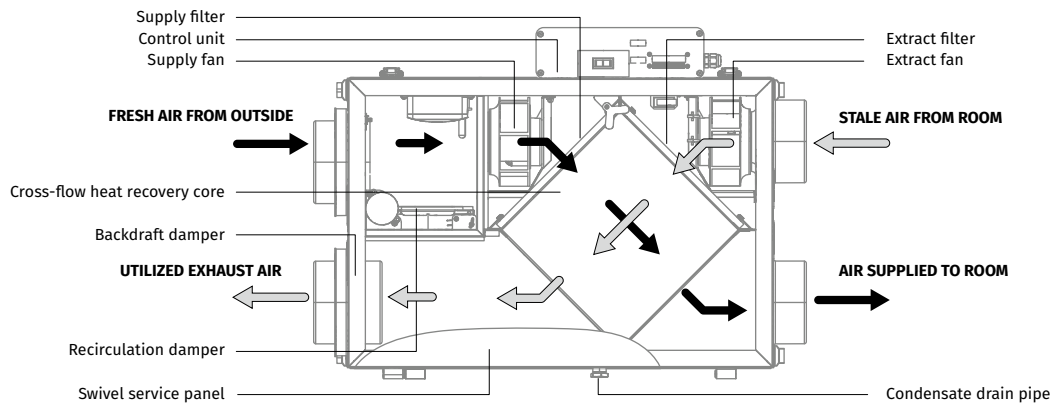

HRV D(R) / ERV D(R) SERIES

**ERV DR 150**

External Static Pressure		Net Supply Air Flow		Gross Air Flow				Power
Pa	in WG	l/s	CFM	Supply		Exhaust		Watts
				l/s	CFM	l/s	CFM	
25	0.1	84	178	85	180	83	176	189
50	0.2	79	167	80	170	79	167	189
75	0.3	75	159	76	161	74	157	186
100	0.4	71	150	72	153	69	146	185
125	0.5	67	142	67	142	64	136	183
150	0.6	62	131	63	133	60	127	181
175	0.7	58	123	58	123	55	117	179
200	0.8	53	112	53	112	50	106	176
225	0.9	48	102	49	104	46	97	174
250	1	43	91	43	91	41	87	171

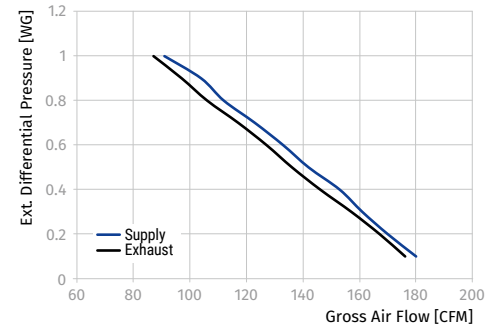

Note: fan curve performed on high speed

Temp Mode	Supply Temp [°C]	Supply Temp [°F]	Net Air Flow [l/s]	Net Air Flow [CFM]	Watts	SRE	ASRE	Latent Recovery / Moisture Transfer	TRE	ATRE
Heating	0	32	31	66	102	66	76	0.50		
	0	32	46	97	130	63	72	0.50		
	0	32	50	106	138	63	71	0.41		
Cooling	35	95	31	66	100			0.34	39	44
	35	95	46	97	132			0.31	35	40

Model	Volts	Max. Watts	Max. Amps
ERV DR 150	120 V, 60 Hz	189	1.6

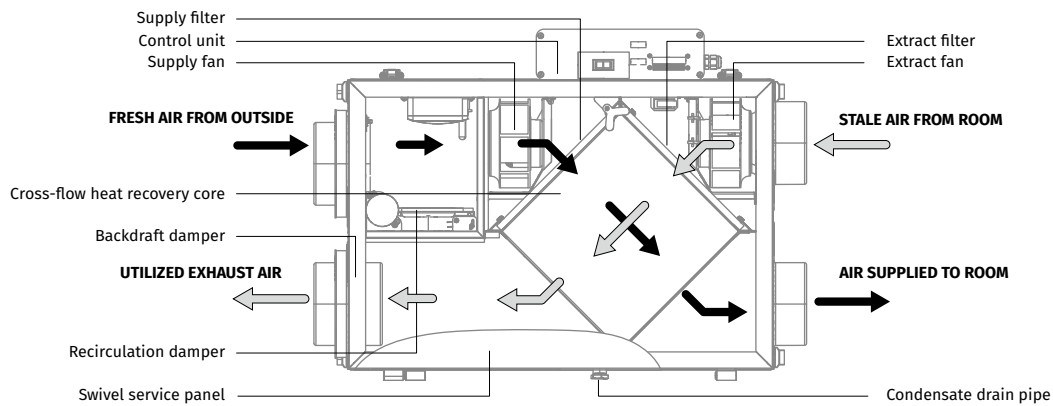

HRV D(R) / ERV D(R) SERIES

# ERV EC D(R) 80

## Energy Recovery Ventilator

Energy Recovery Ventilators are the complete whole house ventilation system designed to bring a continuous supply of fresh air into the house while exhausting an equal amount of stale air.



HRV EC D(R) / ERV EC D(R) SERIES

### Description

- 81 CFM airflow rate provides effective ventilation in apartment overcoming high pressure in condo tower duct systems.
- Cross flow core ensures up to 73 % SRE.
- Slim casing design (8 7/16") is perfect for in-ceiling installation.
- built-in control board enables Supply and Exhaust fan independent speed adjustment from 0 to 100 % right at the job side.
- Fast and simple mounting process thanks to brackets system.
- Automatic recirculation damper (R option) for effective cold protection.
- No drain needed (ERV).
- Up to 1.72 CFM/W (Energy Star requirement – 1.2 CFM/W).

### Casing

- Steel casing is covered with high-quality multilayer aluminium and zinc alloy to prevent corrosion.
- The casing is equipped with a switch to turn the ventilator off when the service panel is opened.

### Filter

- Washable MERV 6 air filters in exhaust and supply air streams.
- Optional supply: anti grease aluminum filter.

### Fans

- High efficient electronically commutated motors with external motor and impeller with backward curved blades. EC motors are featured with high performance and total speed controllable range. The electric motors and impellers are dynamically balanced.

### Energy Recovery Core

- Enthalpic core (ERV EC D(R) 80) provides both heat&humidity recovery. For enthalpic core no drain required.



### Defrost System

- Defrost system is activated when the outdoor temperature falls below 23 °F.
- Recirculation defrost ERV EC D(R) 80.
- Fan stop defrost ERV EC D 80.

### Constant Flow

- ERV EC D(R) 80 CF has an automatic constant air flow control function to keep the air flow in supply and exhaust air ducts constant even in case of variable air resistance.
- This function is provided with the integrated air flow control units. The electronic sensors convert the actual air flow to the analogue signal that is proportional to the air flow in the air duct. These signals are transmitted to the controller that controls the rotation speed of a respective fan in such a way that the actual rotations speed is equal to the set value.









### Manual Balancing

- Manual balancing is a standard balancing system. Fan speed manually adjusted by operating on units controller (built-in control board with independent fan speed adjustment 0 %-100 %).

### Control

- The unit incorporates an integrated automation and control system with following functions:
  - Operation mode switch.
  - Air flow balancing enabled by supply and exhaust fan independent speed adjustment from 0 to 100 % (percentage is displayed on built-in screen).
  - Automatic recovery core frost protection.
  - External control device connection (up to 5 at the same time).

#### Accessories

Backdraft Dampers	Air Disk Valves	Clamps	Push Button Timer	CO <sub>2</sub> Sensors	Humidistat	Wall Speed Controller	Wall Control Panel
							
VRV	VPR	K	S52	CD-1	CD-2	HR-S	CDP-2/5

### Mounting

- Due to low height of the casing the units offer perfect solution for the false ceiling installation in limited space.
- Brackets system makes mounting process easy and fast.



Step 1

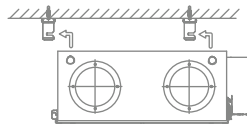

Step 2

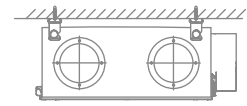

Step 3

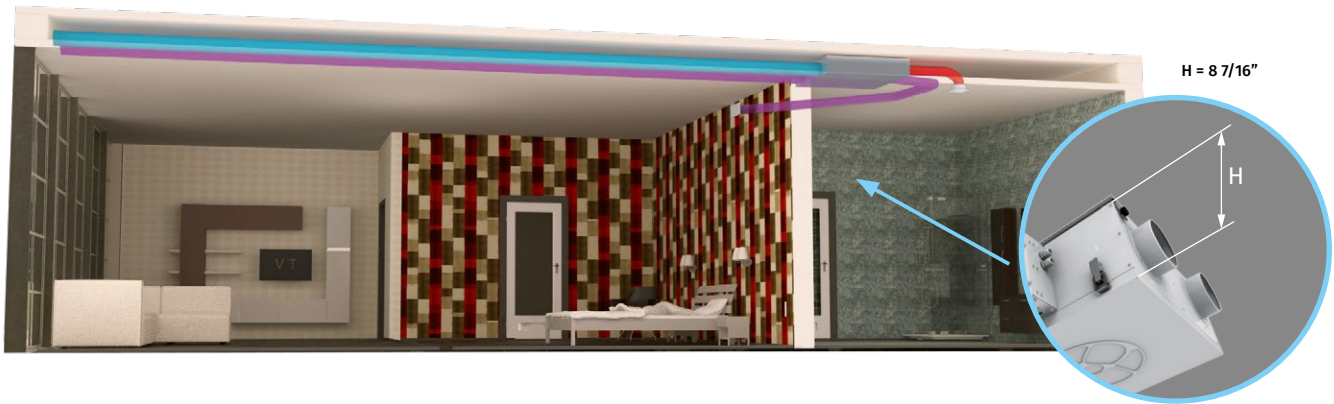

### Dimensions

#### ERV EC D 80

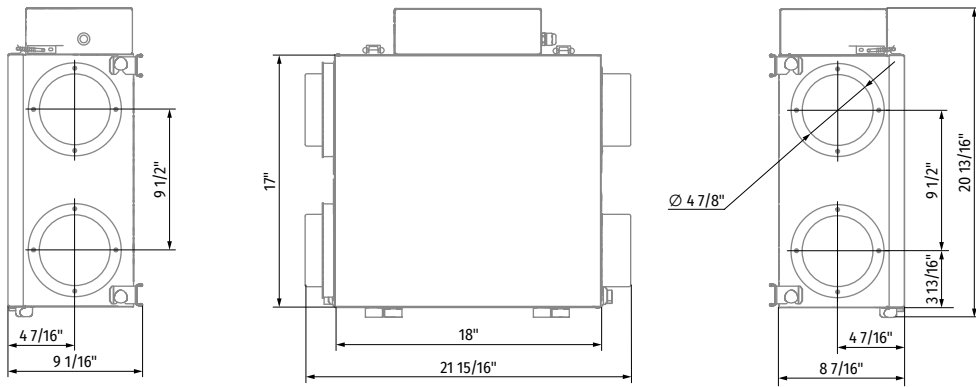

#### ERV EC DR 80

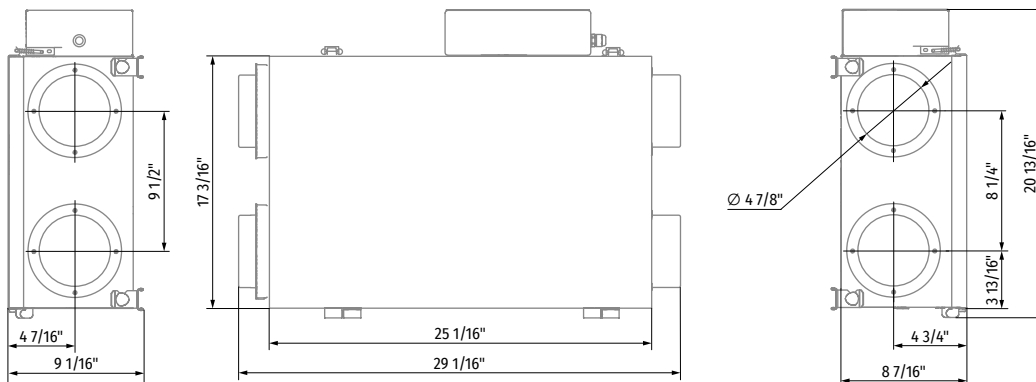

**Technical Data**

**ERV EC D 80**

External Static Pressure		Net Supply Air Flow		Gross Air Flow				Power
Pa	in WG	l/s	CFM	Supply		Exhaust		Watts
				l/s	CFM	l/s	CFM	
25	0.1	38	81	40	84	42	88	61
50	0.2	35	74	36	76	38	81	61
75	0.3	32	67	33	69	35	74	61
100	0.4	29	61	30	63	31	65	60
125	0.5	26	54	26	56	27	57	61
150	0.6	22	46	23	48	22	47	60
175	0.7	17	37	18	38	17	36	58
200	0.8	12	26	13	27	12	26	59
225	0.9	8	16	7	14	8	17	55

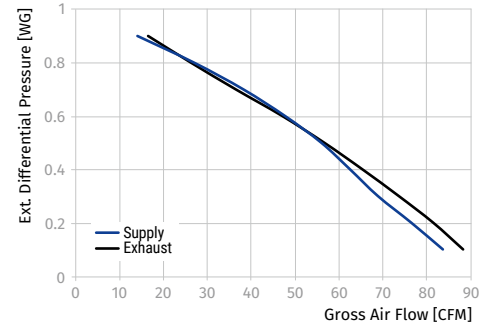

Note: fan curve performed on high speed

		Supply Temperature		Net Air Flow		Average Power [Watts]	Sensible Recovery Efficiency	Apparent Sensible Effectiveness	Net Moisture Transfer
		°C	°F	l/s	CFM				
Heating	I	0	32	20	42	25	73	82	0.46
	II	0	32	25	53	38	69	79	0.47
	III	0	32	30	63	49	68	78	0.45
	IV								
	V	-25	-13	20	42				
				**Total Recovery Efficiency					
Cooling	VI	35	95	20	42	25	54.5**	72	0.49

\*\* Indicates total recovery efficiency, not sensible recovery efficiency 250 Pa = 1 in of water: 0.472 l/s = 1 CFM

Model	Volts	Max. Watts	Max. Amps
ERV EC D 80	120 V, 60 Hz	61	0.9

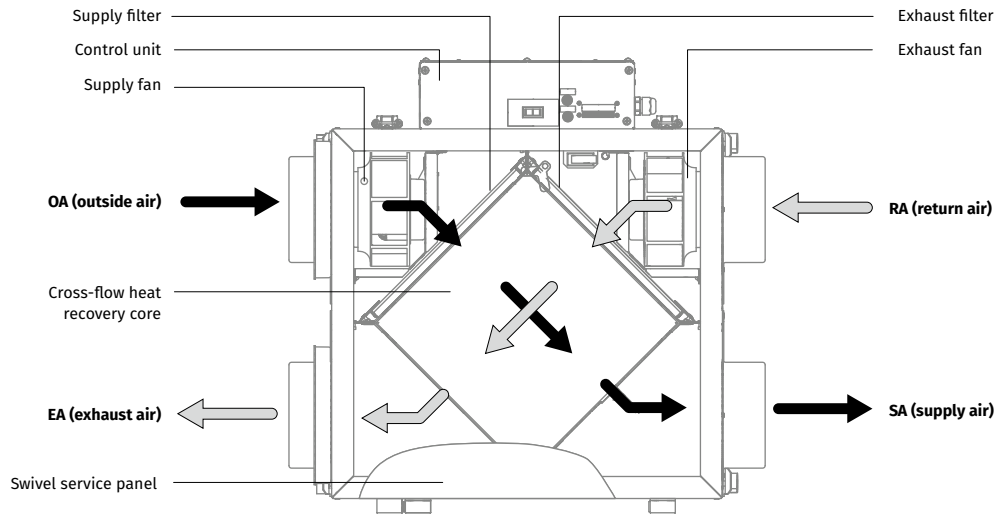

HRV EC D(R) / ERV EC D(R) SERIES



**ERV EC DR 80**

External Static Pressure		Net Supply Air Flow		Gross Air Flow				Power
Pa	in WG	l/s	CFM	Supply		Exhaust		Watts
				l/s	CFM	l/s	CFM	
25	0.1	38	81	40	84	42	88	61
50	0.2	35	74	36	76	38	81	61
75	0.3	32	67	33	69	35	74	61
100	0.4	29	61	30	63	31	65	60
125	0.5	26	54	26	56	27	57	61
150	0.6	22	46	23	48	22	47	60
175	0.7	17	37	18	38	17	36	58
200	0.8	12	26	13	27	12	26	59
225	0.9	8	16	7	14	8	17	55

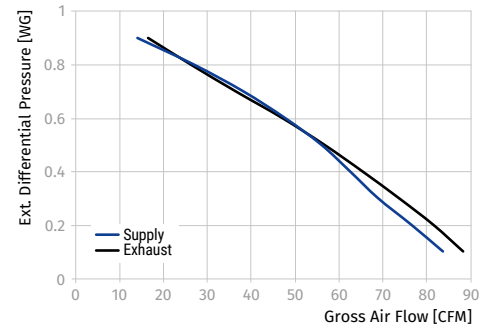

Note: fan curve performed on high speed

		Supply Temperature		Net Air Flow		Average Power [Watts]	Sensible Recovery Efficiency	Apparent Sensible Effectiveness	Net Moisture Transfer
		°C	°F	l/s	CFM				
Heating	I	0	32	20	42	25	73	82	0.46
	II	0	32	25	53	38	69	79	0.47
	III	0	32	30	63	49	68	78	0.45
	IV								
	V	-25	-13	20	42				
**Total Recovery Efficiency									
Cooling	VI	35	95	20	42	25	54.5**	72	0.49

Model	Volts	Max. Watts	Max. Amps
ERV EC DR 80	120 V, 60 Hz	61	0.9

\*\* Indicates total recovery efficiency, not sensible recovery efficiency 250 Pa = 1 in of water: 0.472 l/s = 1 CFM

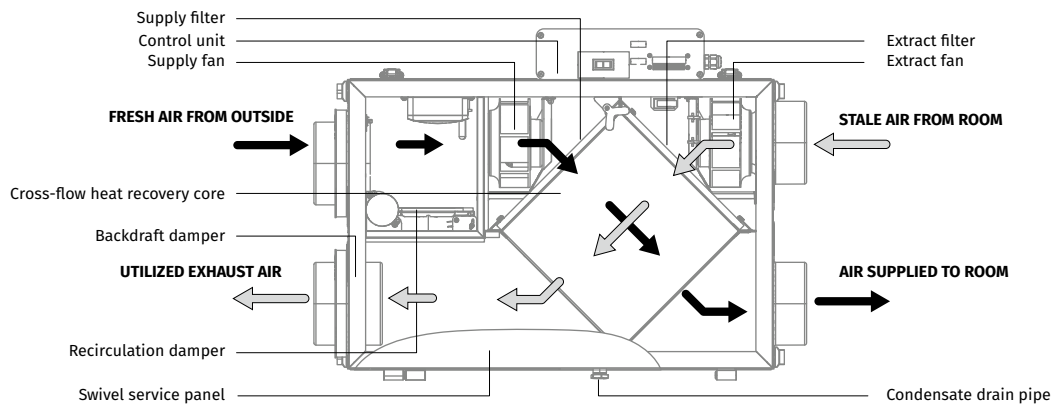

HRV EC D(R) / ERV EC D(R) SERIES

# HRV EC D(R) 120 / ERV EC D(R) 120

## Heat and Energy Recovery Ventilators

Heat and Energy Recovery Ventilators are the complete whole house ventilation system designed to bring a continuous supply of fresh air into the house while exhausting an equal amount of stale air.



HRV EC D(R) / ERV EC D(R) SERIES

### Description

- 189 CFM airflow rate provides effective ventilation in apartment overcoming high pressure in condo tower duct systems.
- Cross flow core ensures up to 72 % SRE.
- Slim casing design (9 1/16") is perfect for in-ceiling installation.
- built-in control board enables Supply and Exhaust fan independent speed adjustment from 0 to 100 % right at the job side.
- Fast and simple mounting process thanks to brackets system.
- Automatic recirculation damper (R option) for effective cold protection.
- No drain needed (ERV).
- Up to 2.83 CFM/W (Energy Star requirement – 1.2 CFM/W).

### Casing

- Steel casing is covered with high-quality multilayer aluminium and zinc alloy to prevent corrosion.
- The casing is equipped with a switch to turn the ventilator off when the service panel is opened.

### Filter

- Washable MERV 6 air filters in exhaust and supply air streams.
- Optional supply: anti grease aluminum filter.

### Fans

- High efficient electronically commutated motors with external motor and impeller with forward curved blades. EC motors are featured with high performance and total speed controllable range. The electric motors and impellers are dynamically balanced.

### Defrost System

- Defrost system is activated when the outdoor temperature falls below 23 °F.
- Recirculation defrost HRV/ERV EC DR 120.
- Fan stop defrost HRV/ERV EC D 120.

### Manual Balancing

- Manual balancing is a standard balancing system. Fan speed manually adjusted by operating on units controller (built-in control board with independent fan speed adjustment 0 %-100 %).

### Heat and Energy Recovery Core

#### HEAT RECOVERY CORE

- Polystyrene core (**HRV EC D(R) 120**) ensures efficient heat recovery.



#### ENERGY RECOVERY CORE

- Enthalpic core (**ERV EC D(R) 120**) provides both heat&humidity recovery. For enthalpic core no drain required.











### Constant Flow

- HRV EC D(R) 120 CF, ERV EC D(R) 120 CF has an automatic constant air flow control function to keep the air flow in supply and exhaust air ducts constant even in case of variable air resistance.
- This function is provided with the integrated air flow control units. The electronic sensors convert the actual air flow to the analogue signal that is proportional to the air flow in the air duct. These signals are transmitted to the controller that controls the rotation speed of a respective fan in such a way that the actual rotations speed is equal to the set value.

### Control

- The unit incorporates an integrated automation and control system with following functions:
  - Operation mode switch.
  - Air flow balancing enabled by supply and exhaust fan independent speed adjustment from 0 to 100 % (percentage is displayed on built-in screen).
  - Automatic recovery core frost protection.
  - External control device connection (up to 5 at the same time).

#### Accessories

Backdraft Dampers	Air Disk Valves	Clamps	Push Button Timer	CO <sub>2</sub> Sensors	Humidistat	Wall Speed Controller	Wall Control Panel
							
VRV	VPR	K	S52	CD-1	CD-2	HR-S	CDP-2/5
							AC208EM2+LP

**Mounting**

- Due to low height of the casing the units offer perfect solution for the false ceiling installation in limited space.
- Brackets system makes mounting process easy and fast.

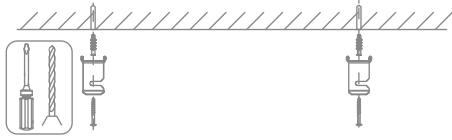

Step 1

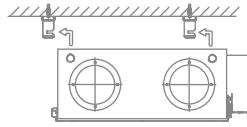

Step 2

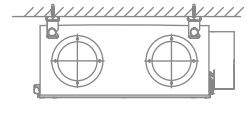

Step 3

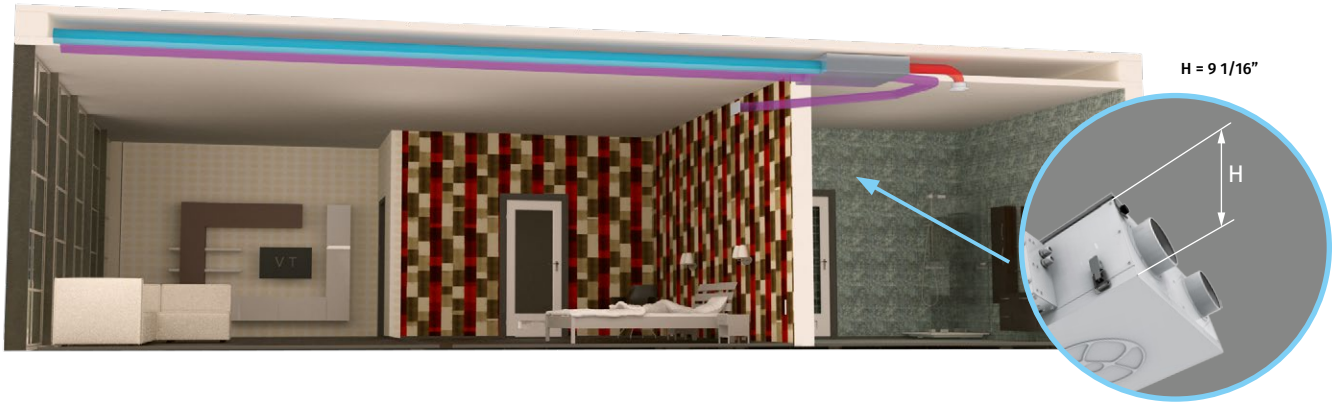

**Dimensions**

**HRV EC D 120 / ERV EC D 120**

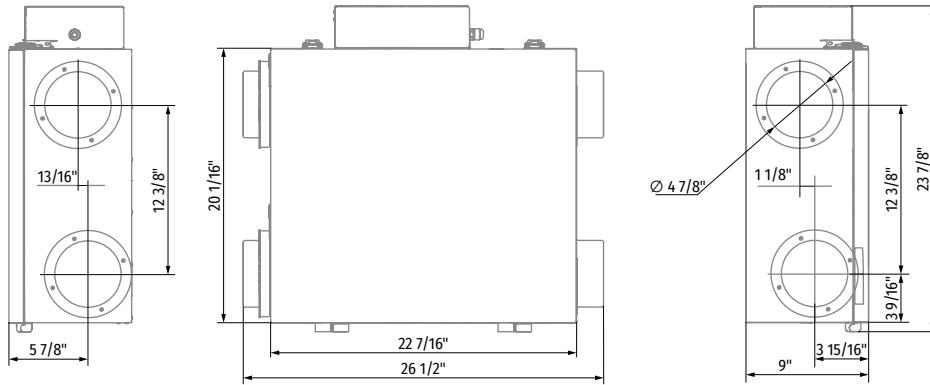

**HRV EC DR 120 / ERV EC DR 120**

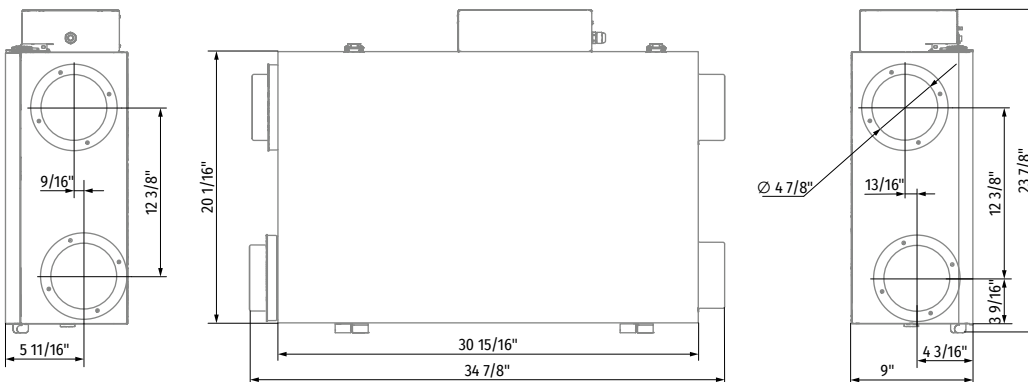

**Technical Data**

**HRV EC D 120**

External Static Pressure		Net Supply Air Flow		Gross Air Flow				Power
Pa	in WG	l/s	CFM	Supply		Exhaust		Watts
				l/s	CFM	l/s	CFM	
25	0.1	89	189	92	195	83	175	204
50	0.2	87	185	90	190	81	171	201
75	0.3	85	180	88	185	79	167	200
100	0.4	82	175	85	180	78	164	198
125	0.5	80	169	82	175	76	161	196
150	0.6	78	165	80	170	75	159	194
175	0.7	76	160	78	165	74	157	193
200	0.8	74	156	76	161	73	154	190
225	0.9	68	144	74	156	70	149	188

External Static Pressure		Net Supply Air Flow		Gross Air Flow				Power
Pa	in WG	l/s	CFM	Supply		Exhaust		Watts
				l/s	CFM	l/s	CFM	
250	1	66	140	71	151	68	144	186
275	1.1	64	135	69	145	66	139	183
300	1.2	61	128	66	140	63	132	180
325	1.3	57	121	63	134	59	125	176
350	1.4	52	110	60	127	54	114	176
375	1.5	43	91	55	117	44	94	164
400	1.6	30	64	44	92	31	67	151
425	1.7	17	35	18	37	17	36	132
450	1.8	8	16	7	14	8	16	128

Note: fan curve performed on high speed

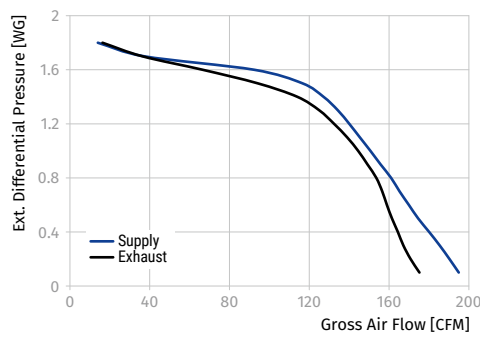

		Supply Temperature		Net Air Flow		Average Power	Sensible Recovery Efficiency	Apparent Sensible Effectiveness	Net Moisture Transfer
		°C	°F	l/s	CFM	[Watts]			
Heating	I	0	32	30	64	86	60	70	0.05
	II	0	32	45	95	114	57	67	0.04
	III	0	32	50	106	126	55	65	0.04
**Total Recovery Efficiency									
Cooling	VI	35	95	30	64	86	29**	61	0.04

\*\* Indicates total recovery efficiency, not sensible recovery efficiency 250 Pa = 1 in of water: 0.472 l/s = 1 CFM

Model	Volts	Max. Watts	Max. Amps
HRV EC D 120	120 V, 60 Hz	189	2.6

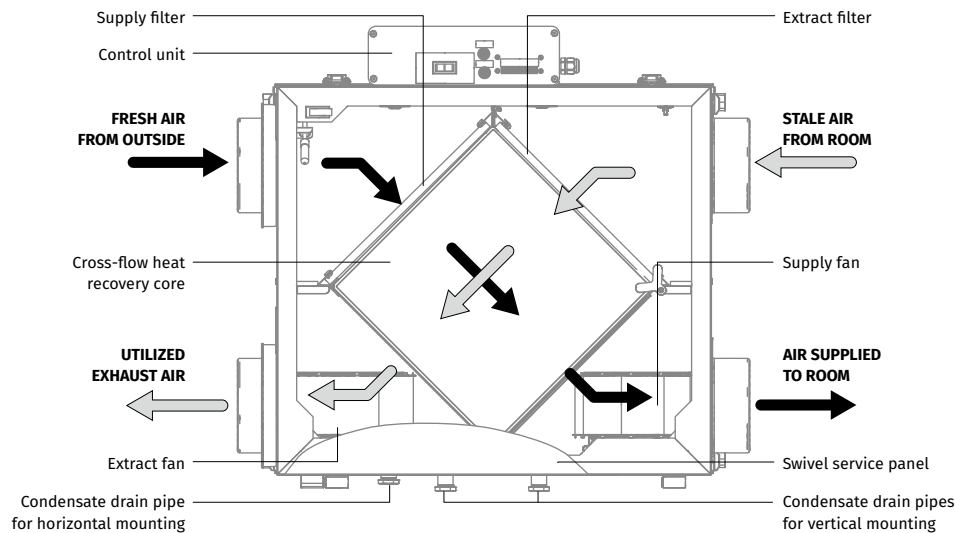

HRV EC D(R) / ERV EC D(R) SERIES

**ERV EC D 120**

External Static Pressure		Net Supply Air Flow		Gross Air Flow				Power
Pa	in WG	l/s	CFM	Supply		Exhaust		Watts
				l/s	CFM	l/s	CFM	
25	0.1	76	161	78	165	78	165	174
50	0.2	74	157	76	161	76	161	174
75	0.3	73	155	74	157	74	157	175
100	0.4	71	150	73	155	73	155	175
125	0.5	69	146	71	150	71	150	175
150	0.6	68	144	70	148	70	148	175
175	0.7	67	142	68	144	69	146	175
200	0.8	65	138	67	142	68	144	175
225	0.9	64	136	66	140	67	142	175
250	1	63	133	65	138	65	138	175

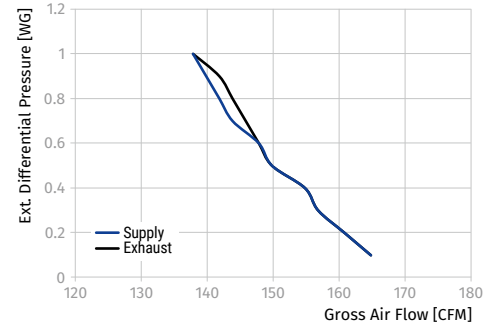

Note: fan curve performed on high speed

Temp Mode	Supply Temp [°C]	Supply Temp [°F]	Net Air Flow [l/s]	Net Air Flow [CFM]	Watts	SRE	ASRE	Latent Recovery / Moisture Transfer	TRE	ATRE	VLTVR Supply	VLTVR Exhaust	Very Low Temp Air Flow Imbalance
Heating	0	32	23	49	18	71	73	0.17					
Cooling	35	95	23	49	18			0.24	39	41			



Model	Volts	Max. Watts	Max. Amps
ERV EC D 120	120 V, 60 Hz	139	1.3

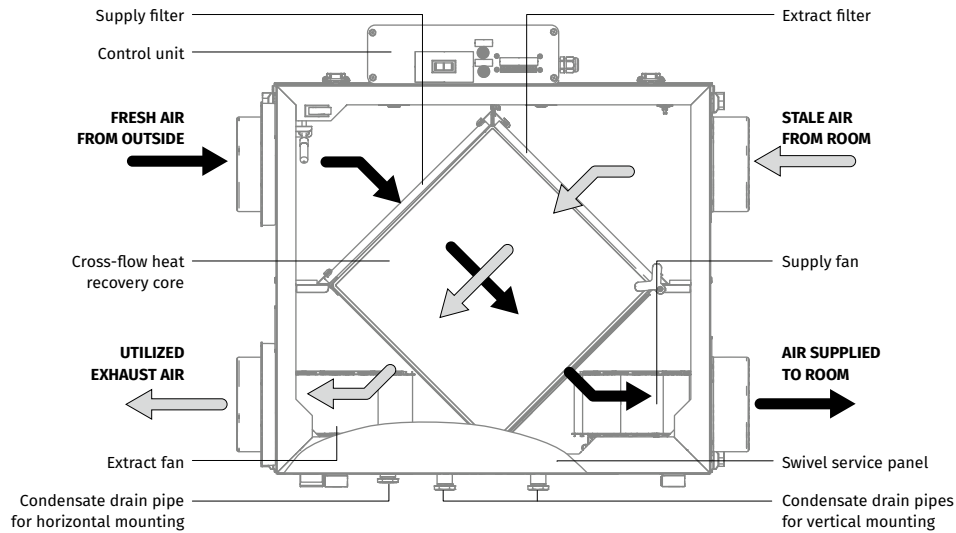

HRV EC D(R) / ERV EC D(R) SERIES

**HRV EC DR 120**

External Static Pressure		Net Supply Air Flow		Gross Air Flow				Power
Pa	in WG	l/s	CFM	Supply		Exhaust		
				l/s	CFM	l/s	CFM	Watts
25	0.1	89	189	92	195	83	175	204
50	0.2	87	185	90	190	81	171	201
75	0.3	85	180	88	185	79	167	200
100	0.4	82	175	85	180	78	164	198
125	0.5	80	169	82	175	76	161	196
150	0.6	78	165	80	170	75	159	194
175	0.7	76	160	78	165	74	157	193
200	0.8	74	156	76	161	73	154	190
225	0.9	68	144	74	156	70	149	188

External Static Pressure		Net Supply Air Flow		Gross Air Flow				Power
Pa	in WG	l/s	CFM	Supply		Exhaust		
				l/s	CFM	l/s	CFM	Watts
250	1	66	140	71	151	68	144	186
275	1.1	64	135	69	145	66	139	183
300	1.2	61	128	66	140	63	132	180
325	1.3	57	121	63	134	59	125	176
350	1.4	52	110	60	127	54	114	176
375	1.5	43	91	55	117	44	94	164
400	1.6	30	64	44	92	31	67	151
425	1.7	17	35	18	37	17	36	132
450	1.8	8	16	7	14	8	16	128

Note: fan curve performed on high speed

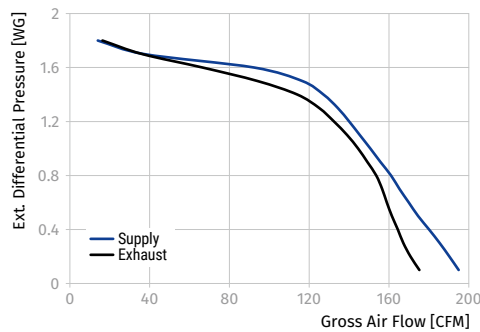

HRV EC D(R) / ERV EC D(R) SERIES

		Supply Temperature		Net Air Flow		Average Power [Watts]	Sensible Recovery Efficiency	Apparent Sensible Effectiveness	Net Moisture Transfer
		°C	°F	l/s	CFM				
Heating	I	0	32	31	66	23	62	69	0.05
	II	0	32	45	95	50	60	67	0.04
	III	0	32	50	106	66	58	65	0.04
	IV								
	V	-25	-13	25	53	24	52	76	0.36
**Total Recovery Efficiency									
Cooling	VI	35	95	31	66	23	37**	61	0.04

\*\* Indicates total recovery efficiency, not sensible recovery efficiency 250 Pa = 1 in of water: 0.472 l/s = 1 CFM

Model	Volts	Max. Watts	Max. Amps
HRV EC DR 120	120 V, 60 Hz	189	2.6

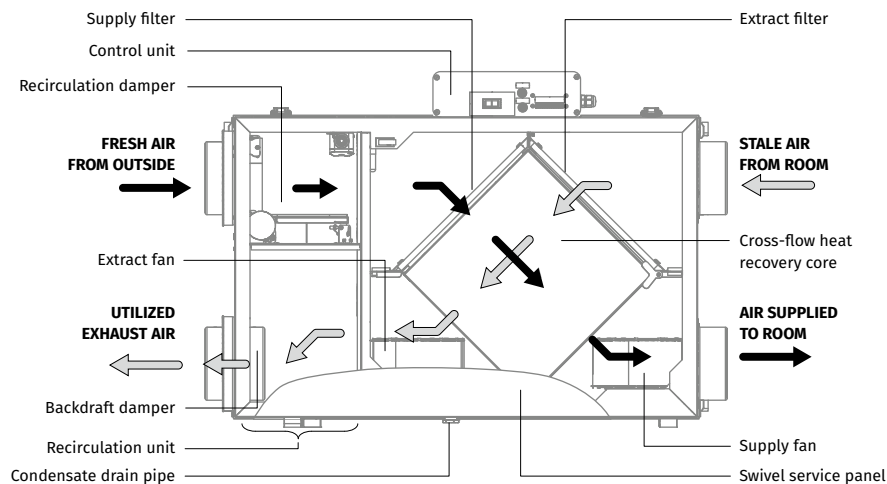

**ERV EC DR 120**

External Static Pressure		Net Supply Air Flow		Gross Air Flow				Power
Pa	in WG	l/s	CFM	Supply		Exhaust		Watts
				l/s	CFM	l/s	CFM	
25	0.1	71	150	73	155	69	146	128
50	0.2	68	144	69	146	66	140	124
75	0.3	66	140	67	142	63	133	119
100	0.4	63	133	65	138	61	129	115
125	0.5	61	129	63	133	58	123	111
150	0.6	59	125	60	127	55	117	107
175	0.7	56	119	58	123	52	110	101
200	0.8	53	112	54	114	49	104	96
225	0.9	48	102	49	104	44	93	89
250	1	41	87	42	89	39	83	78

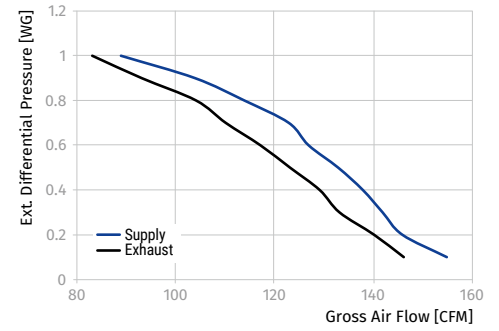

Note: fan curve performed on high speed

Temp Mode	Supply Temp [°C]	Supply Temp [°F]	Net Air Flow [l/s]	Net Air Flow [CFM]	Watts	SRE	ASRE	Latent Recovery / Moisture Transfer	TRE	ATRE	VLTVR Supply	VLTVR Exhaust	Very Low Temp Air Flow Imbalance
Heating	0	32	24	51	64	68	76	0.66					
	-25	-13	25	51	97	50	54	0.46			29.3	15.2	84
Cooling	35	95	24	51	62			0.54	51	56			



Model	Volts	Max. Watts	Max. Amps
ERV EC DR 120	120 V, 60 Hz	128	2.5

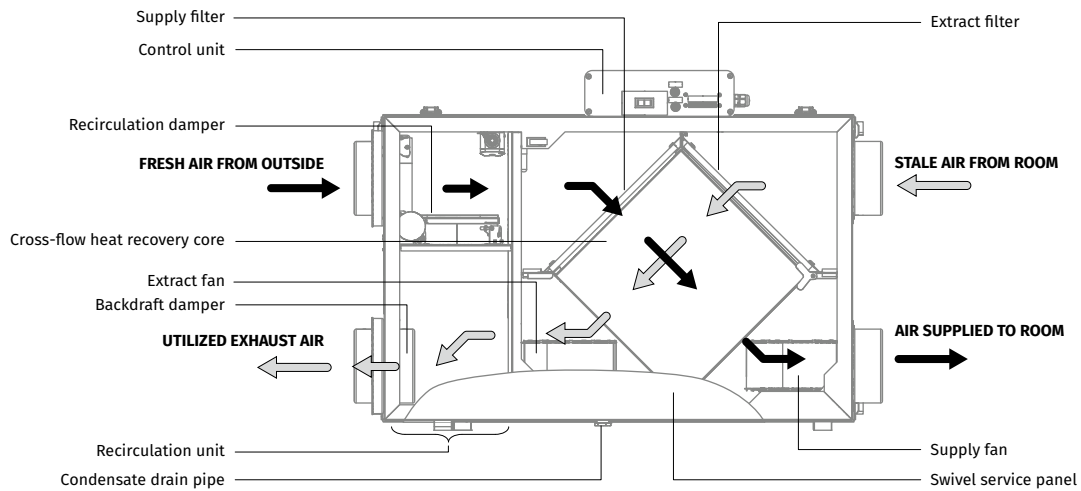

HRV EC D(R) / ERV EC D(R) SERIES

# HRV EC D(R) 150 / ERV EC D(R) 150

## Heat and Energy Recovery Ventilators

Heat and Energy Recovery Ventilators are the complete whole house ventilation system designed to bring a continuous supply of fresh air into the house while exhausting an equal amount of stale air.



HRV EC D(R) / ERV EC D(R) SERIES

### Description

- 186 CFM airflow rate provides effective ventilation in apartment overcoming high pressure in condo tower duct systems.
- Cross flow core ensures up to 73 % SRE.
- Slim casing design (9 1/8") is perfect for in-ceiling installation.
- built-in control board enables Supply and Exhaust fan independent speed adjustment from 0 to 100 % right at the job side.
- Fast and simple mounting process thanks to brackets system.
- Automatic recirculation damper (R option) for effective cold protection.
- No drain needed (ERV).
- Up to 2.56 CFM/W (Energy Star requirement – 1.2 CFM/W).

### Casing

- Steel casing is covered with high-quality multilayer aluminium and zinc alloy to prevent corrosion.
- The casing is equipped with a switch to turn the ventilator off when the service panel is opened.

### Filter

- Washable MERV 6 air filters in exhaust and supply air streams.
- Optional supply: anti grease aluminum filter.

### Fans

- High efficient electronically commutated motors with external motor and impeller with backward curved blades. EC motors are featured with high performance and total speed controllable range. The electric motors and impellers are dynamically balanced.

### Defrost System

- Defrost system is activated when the outdoor temperature falls below 23 °F.
- Recirculation defrost HRV/ERV EC DR 150.
- Fan stop defrost HRV/ERV EC D 150.

### Manual Balancing

- Manual balancing is a standard balancing system. Fan speed manually adjusted by operating on units controller (built-in control board with independent fan speed adjustment 0 %-100 %).

### Heat and Energy Recovery Core

#### HEAT RECOVERY CORE

- Polystyrene core (**HRV EC D(R) 150**) ensures efficient heat recovery.



#### ENERGY RECOVERY CORE

- Enthalpic core (**ERV EC D(R) 150**) provides both heat&humidity recovery. For enthalpic core no drain required.











### Constant Flow

- HRV EC D(R) 150 CF, ERV EC D(R) 150 CF has an automatic constant air flow control function to keep the air flow in supply and exhaust air ducts constant even in case of variable air resistance.
- This function is provided with the integrated air flow control units. The electronic sensors convert the actual air flow to the analogue signal that is proportional to the air flow in the air duct. These signals are transmitted to the controller that controls the rotation speed of a respective fan in such a way that the actual rotations speed is equal to the set value.

### Control

- The unit incorporates an integrated automation and control system with following functions:
  - Operation mode switch.
  - Air flow balancing enabled by supply and exhaust fan independent speed adjustment from 0 to 100 % (percentage is displayed on built-in screen).
  - Automatic recovery core frost protection.
  - External control device connection (up to 5 at the same time).

#### Accessories

Backdraft Dampers	Air Disk Valves	Clamps	Push Button Timer	CO <sub>2</sub> Sensors	Humidistat	Wall Speed Controller	Wall Control Panel
							
VRV	VPR	K	S52	CD-1	CD-2	HR-S	CDP-2/5 AC208EM2+LP



**Mounting**

- Due to low height of the casing the units offer perfect solution for the false ceiling installation in limited space.
- Brackets system makes mounting process easy and fast.



Step 1

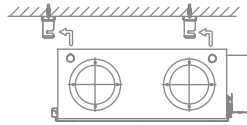

Step 2

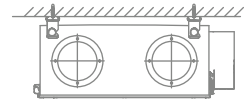

Step 3

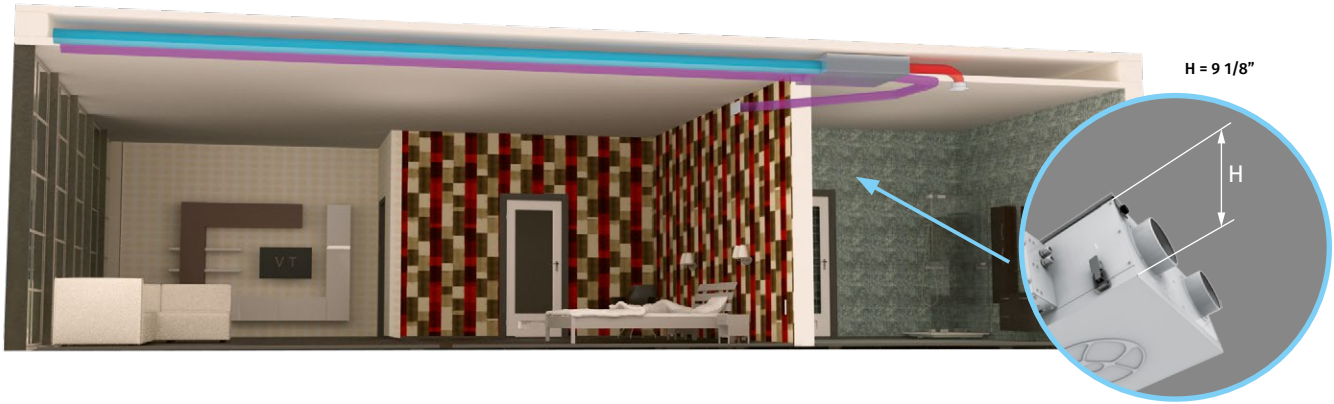

**Dimensions**

**HRV EC D 150 / ERV EC D 150**

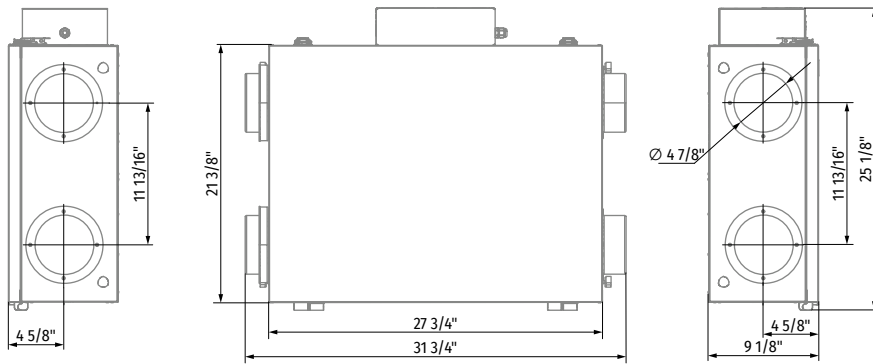

**HRV EC DR 150 / ERV EC DR 150**

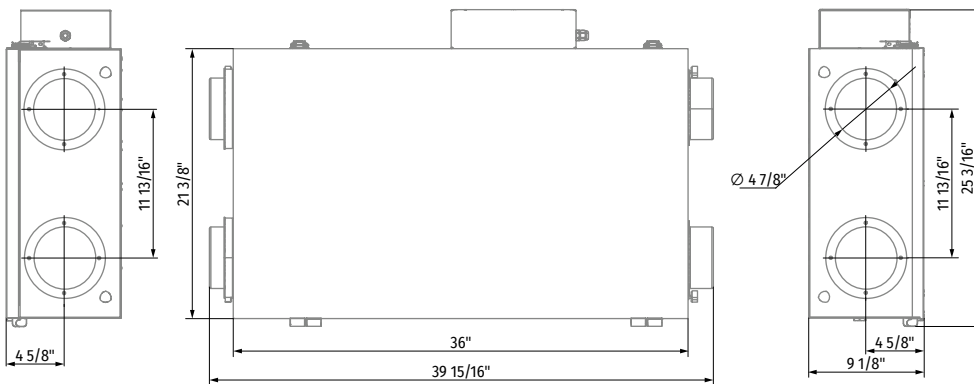

**Technical Data**

**HRV EC D 150**

External Static Pressure		Net Supply Air Flow		Gross Air Flow				Power
Pa	in WG	l/s	CFM	Supply		Exhaust		Watts
				l/s	CFM	l/s	CFM	
25	0.1	85	181	88	186	81	171	186
50	0.2	82	175	85	180	78	165	186
75	0.3	80	169	82	174	75	159	186
100	0.4	77	162	79	167	72	153	185
125	0.5	74	156	76	161	70	147	185
150	0.6	70	149	73	154	67	141	184
175	0.7	67	142	69	146	64	135	184
200	0.8	64	135	66	139	61	128	184
225	0.9	55	117	62	131	57	121	183
250	1	52	110	58	123	54	114	182
275	1.1	49	104	54	115	51	107	181

External Static Pressure		Net Supply Air Flow		Gross Air Flow				Power
Pa	in WG	l/s	CFM	Supply		Exhaust		Watts
				l/s	CFM	l/s	CFM	
300	1.2	45	96	50	107	47	99	181
325	1.3	42	88	46	97	43	91	180
350	1.4	38	80	41	88	39	83	178
375	1.5	34	73	37	78	36	75	176
400	1.6	30	64	32	69	31	66	174
425	1.7	26	54	28	58	27	56	172
450	1.8	21	45	22	47	22	47	169
475	1.9	16	35	17	36	17	36	166
500	2	12	24	12	25	12	25	163
525	2.1	6	14	7	14	7	14	159
550	2.2	2	4	2	3	2	4	156

Note: fan curve performed on high speed

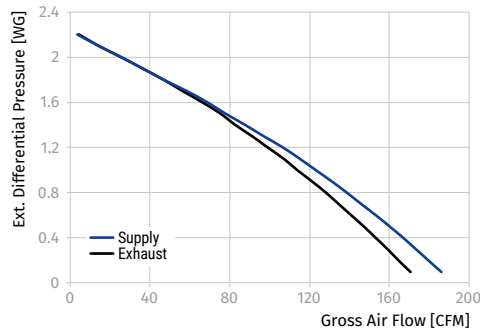

HRV EC D(R) / ERV EC D(R) SERIES

		Supply Temperature		Net Air Flow		Average Power	Sensible Recovery Efficiency	Apparent Sensible Effectiveness	Net Moisture Transfer
		°C	°F	l/s	CFM	[Watts]			
Heating	I	0	32	31	66	26	69	78	0.04
	II	0	32	46	97	42	67	74	0.05
	III	0	32	50	107	52	65	73	0.05
	IV								
	V	-25	-13						
**Total Recovery Efficiency									
Cooling	VI	35	95	31	66	25.8	40.2**	64	0.04

\*\* Indicates total recovery efficiency, not sensible recovery efficiency 250 Pa = 1 in of water: 0.472 l/s = 1 CFM

Model	Volts	Max. Watts	Max. Amps
HRV EC D 150	120 V, 60 Hz	186	2.5

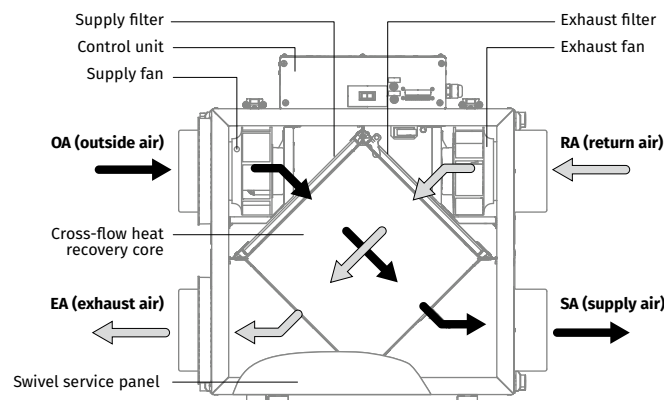

**ERV EC D 150**

External Static Pressure		Net Supply Air Flow		Gross Air Flow				Power
Pa	in WG	I/s	CFM	Supply		Exhaust		
				I/s	CFM	I/s	CFM	Watts
25	0.1	85	181	88	186	81	171	186
50	0.2	82	175	85	180	78	165	186
75	0.3	80	169	82	174	75	159	186
100	0.4	77	162	79	167	72	153	185
125	0.5	74	156	76	161	70	147	185
150	0.6	70	149	73	154	67	141	184
175	0.7	67	142	69	146	64	135	184
200	0.8	64	135	66	139	61	128	184
225	0.9	55	117	62	131	57	121	183
250	1	52	110	58	123	54	114	182
275	1.1	49	104	54	115	51	107	181

External Static Pressure		Net Supply Air Flow		Gross Air Flow				Power
Pa	in WG	I/s	CFM	Supply		Exhaust		
				I/s	CFM	I/s	CFM	Watts
300	1.2	45	96	50	107	47	99	181
325	1.3	42	88	46	97	43	91	180
350	1.4	38	80	41	88	39	83	178
375	1.5	34	73	37	78	36	75	176
400	1.6	30	64	32	69	31	66	174
425	1.7	26	54	28	58	27	56	172
450	1.8	21	45	22	47	22	47	169
475	1.9	16	35	17	36	17	36	166
500	2	12	24	12	25	12	25	163
525	2.1	6	14	7	14	7	14	159
550	2.2	2	4	2	3	2	4	156

Note: fan curve performed on high speed

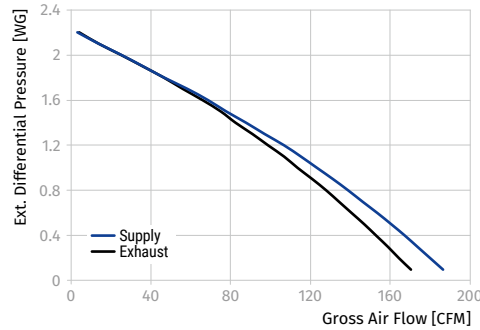

		Supply Temperature		Net Air Flow		Average Power [Watts]	Sensible Recovery Efficiency	Apparent Sensible Effectiveness	Net Moisture Transfer
		°C	°F	I/s	CFM				
Heating	I	0	32	31	66	26	73	82	0.46
	II	0	32	46	97	42	70	78	0.38
	III	0	32	50	107	52	68	75	0.36
	IV								
	V	-25	-13	31	65	89	63	77	0.37
**Total Recovery Efficiency									
Cooling	VI	35	95	31	66	26	50.1**	68	0.42

\*\* Indicates total recovery efficiency, not sensible recovery efficiency 250 Pa = 1 in of water: 0.472 l/s = 1 CFM

Model	Volts	Max. Watts	Max. Amps
ERV EC D 150	120 V, 60 Hz	186	2.5

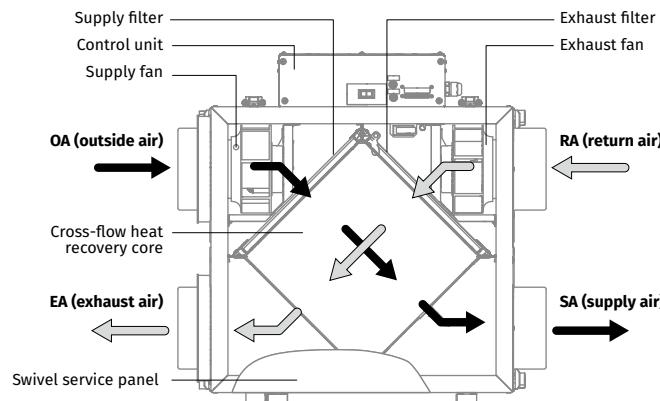

**HRV EC DR 150**

External Static Pressure		Net Supply Air Flow		Gross Air Flow				Power
Pa	in WG	I/s	CFM	Supply		Exhaust		
				I/s	CFM	I/s	CFM	Watts
25	0.1	85	181	88	186	81	171	186
50	0.2	82	175	85	180	78	165	186
75	0.3	80	169	82	174	75	159	186
100	0.4	77	162	79	167	72	153	185
125	0.5	74	156	76	161	70	147	185
150	0.6	70	149	73	154	67	141	184
175	0.7	67	142	69	146	64	135	184
200	0.8	64	135	66	139	61	128	184
225	0.9	55	117	62	131	57	121	183
250	1	52	110	58	123	54	114	182
275	1.1	49	104	54	115	51	107	181

External Static Pressure		Net Supply Air Flow		Gross Air Flow				Power
Pa	in WG	I/s	CFM	Supply		Exhaust		
				I/s	CFM	I/s	CFM	Watts
300	1.2	45	96	50	107	47	99	181
325	1.3	42	88	46	97	43	91	180
350	1.4	38	80	41	88	39	83	178
375	1.5	34	73	37	78	36	75	176
400	1.6	30	64	32	69	31	66	174
425	1.7	26	54	28	58	27	56	172
450	1.8	21	45	22	47	22	47	169
475	1.9	16	35	17	36	17	36	166
500	2	12	24	12	25	12	25	163
525	2.1	6	14	7	14	7	14	159
550	2.2	2	4	2	3	2	4	156

Note: fan curve performed on high speed

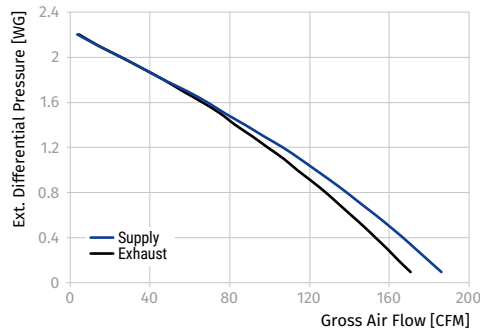

HRV EC D(R) / ERV EC D(R) SERIES

		Supply Temperature		Net Air Flow		Average Power [Watts]	Sensible Recovery Efficiency	Apparent Sensible Effectiveness	Net Moisture Transfer
		°C	°F	I/s	CFM				
Heating	I	0	32	31	66	26	69	78	0.04
	II	0	32	46	97	42	67	74	0.05
	III	0	32	50	107	52	65	73	0.05
	IV								
	V	-25	-13						
**Total Recovery Efficiency									
Cooling	VI	35	95	31	66	25.8	40.2**	64	0.04

\*\* Indicates total recovery efficiency, not sensible recovery efficiency 250 Pa = 1 in of water: 0.472 I/s = 1 CFM

Model	Volts	Max. Watts	Max. Amps
HRV EC DR 150	120 V, 60 Hz	186	2.5

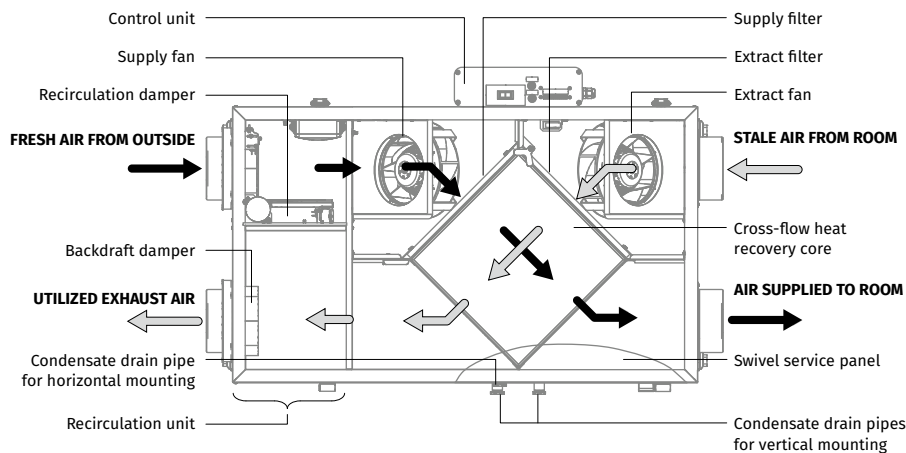

**ERV EC DR 150**

External Static Pressure		Net Supply Air Flow		Gross Air Flow				Power
Pa	in WG	l/s	CFM	Supply		Exhaust		
				l/s	CFM	l/s	CFM	Watts
25	0.1	85	181	88	186	81	171	186
50	0.2	82	175	85	180	78	165	186
75	0.3	80	169	82	174	75	159	186
100	0.4	77	162	79	167	72	153	185
125	0.5	74	156	76	161	70	147	185
150	0.6	70	149	73	154	67	141	184
175	0.7	67	142	69	146	64	135	184
200	0.8	64	135	66	139	61	128	184
225	0.9	55	117	62	131	57	121	183
250	1	52	110	58	123	54	114	182
275	1.1	49	104	54	115	51	107	181

External Static Pressure		Net Supply Air Flow		Gross Air Flow				Power
Pa	in WG	l/s	CFM	Supply		Exhaust		
				l/s	CFM	l/s	CFM	Watts
300	1.2	45	96	50	107	47	99	181
325	1.3	42	88	46	97	43	91	180
350	1.4	38	80	41	88	39	83	178
375	1.5	34	73	37	78	36	75	176
400	1.6	30	64	32	69	31	66	174
425	1.7	26	54	28	58	27	56	172
450	1.8	21	45	22	47	22	47	169
475	1.9	16	35	17	36	17	36	166
500	2	12	24	12	25	12	25	163
525	2.1	6	14	7	14	7	14	159
550	2.2	2	4	2	3	2	4	156

Note: fan curve performed on high speed

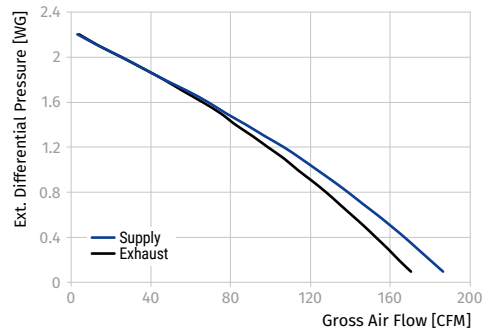

		Supply Temperature		Net Air Flow		Average Power [Watts]	Sensible Recovery Efficiency	Apparent Sensible Effectiveness	Net Moisture Transfer
		°C	°F	l/s	CFM				
Heating	I	0	32	31	66	26	73	82	0.46
	II	0	32	46	97	42	70	78	0.38
	III	0	32	50	107	52	68	75	0.36
	IV								
	V	-25	-13	31	65	89	63	77	0.37
**Total Recovery Efficiency									
Cooling	VI	35	95	31	66	26	50.1**	68	0.42

\*\* Indicates total recovery efficiency, not sensible recovery efficiency 250 Pa = 1 in of water: 0.472 l/s = 1 CFM

Model	Volts	Max. Watts	Max. Amps
ERV EC DR 150	120 V, 60 Hz	186	2.5

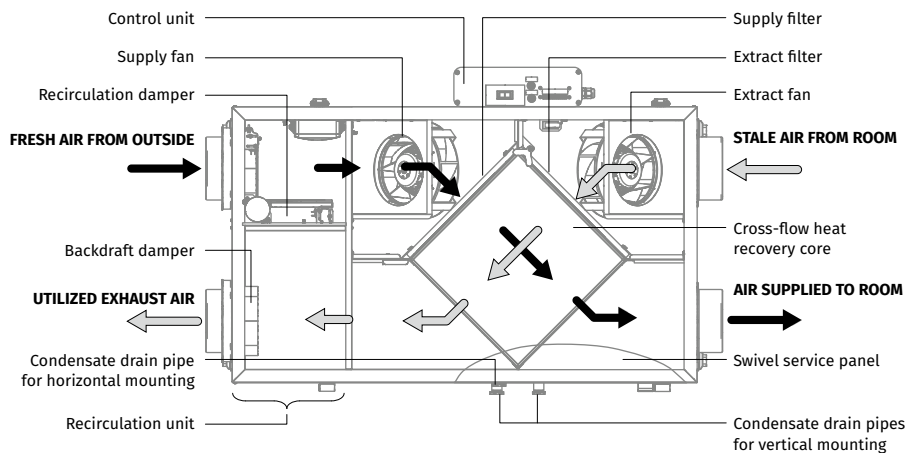

# S52

## 20/40/60 Push Button Timer

An electronic wall control timer that is compatible with all HRV D/ ERV D models. This control activates the system on three possible modes of operation.

The button activates the system to run in intermittent mode for 20/40/60 minutes, it then returns to the predetermined setting. The light indicator of this wall control shows clearly, in which operating mode the unit is.



### Control

- Push once for 20-minute, twice for 40-minute, or three times for 60-minute activation. Indicator lights up and the controlled unit goes to high speed.
- Push once more to stop activation. Unit returns to its previous setting.

### Electrical Diagram

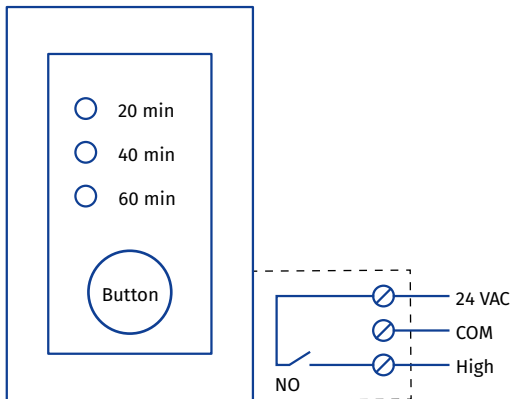

### Specification

- Power supply: 24 VAC ±10 % or 24 VDC ±10 %
- Communication protocol: Normally opened contact
- User interface: Push button
- Type of indication:
  - LED 1 = 20 min timer is active;
  - LED 2 = 40 min timer is active;
  - LED 3 = 60 min timer is active.
- Output voltage: 24 VAC ±10 % or 24 VDC ±10 %
- Current Out: 100 mA, max

# CD-1 / CD-2

## CO<sub>2</sub> Sensors

The sensor is designed for indoor carbon dioxide concentration measurement and respective air capacity regulation through the control output signal to the fan. Air capacity control based on CO<sub>2</sub> concentration is an efficient energy saving solution.



### Design and Compatability

- The sensor has two separate outputs: a normally opened dry relay contact and an analogue output 0...10 V (this output is adjustable for 2...10 V / 0...20 mA / 4...20 mA). The relay output is used to turn the fan on/off depending on indoor CO<sub>2</sub>-concentration and the analogue output is used for smooth fan speed control for a fan with EC-motor or a fan with extra speed controller with 0-10 V input. In case of smooth fan speed control, the fan speed varies proportionally to carbon dioxide emissions. The relay and analogue outputs make the sensor compatible with any ventilation system. The integrated self-calibration system ensures reliable sensor operation during the sensor service life.

### Mounting and Power Supply

- The sensor is designed for wall surface mounting, 24 VAC low current power supply. If power supply 24 V is not available, connect the TRF plug that is offered as an accessory.

### Accessories

- Power supply unit is applied for connection of the sensor to 120 V (TRF-120/24-1.6) AC power mains.

### Electrical Diagram

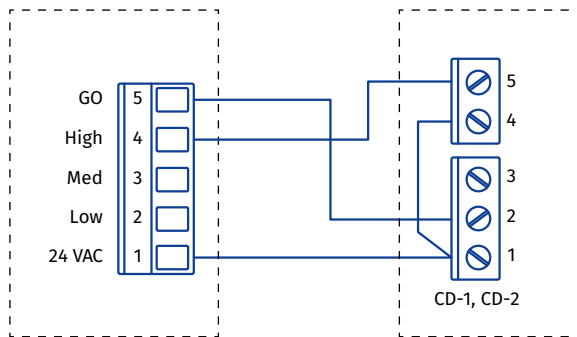

### Modifications

- The sensor is available in two modifications: CD-1 and CD-2. The CD-1 model incorporates LED lights for CO<sub>2</sub> concentration and operation buttons indicating the level of three operation modes: 1 – on, 2 – off, 3 – operation by CO<sub>2</sub> concentration. The button is used to switch the ventilation system on or off when CO<sub>2</sub> – based ventilation control is not required. The CD-2 model has no LED-lights and on/off button. The model is applied for premises requiring permanent ventilation, i.e. at school classes and other public premises.

### Mounting and power supply

Parameters	Value
Power supply / consumption	24 VAC (50/60 Hz ± 10 %), 24 VDC / 1.6 W Max
Gas detection analyzer	Non-dispersive infrared detector (NDIR) with self-calibration system
CO <sub>2</sub> measuring range	0–2.000 ppm (parts per million)
Accuracy at 77 °F, 2.000 ppm	±30 ppm + 3 % of reading
Response time	max. 2 min
Warm up time for each turning-on	2 hours (first time), 2 minutes (operation)
Analogue output	0–10 VDC (default), 4–20 mA selectable by jumpers
On/Off output	1X2 A switch load. Four set points selectable by jumpers
6 LED lights for CO <sub>2</sub> concentration indication (for model CD-1)	1st green indicator lights when CO <sub>2</sub> concentration is below 600 ppm; 1st and 2nd green indicators light when CO <sub>2</sub> concentration is 600–800 ppm; 1st yellow indicator lights when CO <sub>2</sub> concentration is 800–1200 ppm; 1st and 2nd yellow indicators light when CO <sub>2</sub> concentration is 1200–1400 ppm; 1st red indicator lights when CO <sub>2</sub> concentration is 1400–1600 ppm; 1st and 2nd red indicators light when CO <sub>2</sub> concentration is above 1600 ppm
Operating conditions / storage recommendations	0-122 °F; 0-95 % RH non condensing / 0-122 °F
Weight / Dimensions	0.3 lb / 3 15/16" × 3 1/8" × 1 3/16"

# HR-S

## Humidistat

The humidistat is designed for controlling humidification and/or dehumidification in ventilation, air conditioning and heating systems. Can also be used to alarm when the humidity exceeds or falls below a pre-set level.



### Design

- The single-stage humidistat HR-S uses a synthetic element as sensor medium. The synthetic element stretches as the humidity increases and shrinks as the humidity decreases.

### Technical data

Parameters	Value
Switch contact	24 V AC
Moisture [%]	20-90
Casing material	Polycarbonate
Temperature range [°F]	0-104
Mounting	Wall surface mounting
Ingress protection	IP30
Dimensions [in]	3 3/8 x 3 3/8 x 1 3/16

### Wiring diagram

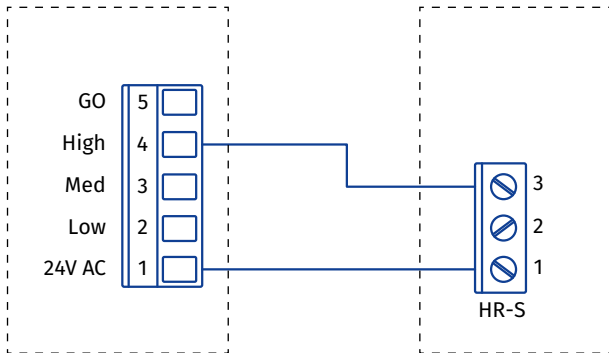

### Mounting

- The humidistat is designed for indoor mounting on the wall surface.

### Humidistat wiring diagram

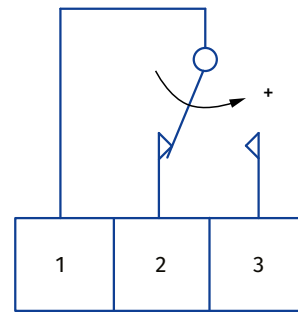

**Humidification** Closing contact between terminals 1 and 2.  
**Dehumidification** Closing contact between terminals 1 and 3



# CDP-2/5

## Wall Speed Controller

Created to optimize both product performance and homeowner comfort. Offers simplified control for ease of use.



### Modes

- The control panel provides the following operating modes:
  - Turning unit off
  - Minimum speed
  - Medium speed
  - Maximum speed

### Compatibility

- Compatible with all HRV/ERV models.

### Electrical Diagram

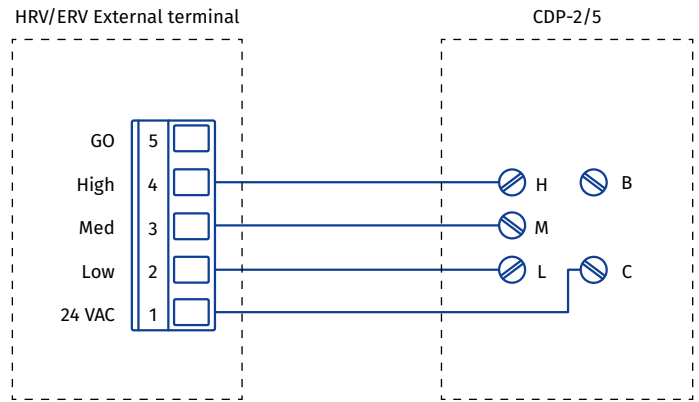

# AC208EM2+LP

## Wall Control Panel

Created to optimize both product performance and homeowner comfort. Offers simplified control for ease of use.



### Modes

- The control panel provides the following operating modes:
  - Turning unit on/off
  - Minimum speed
  - Medium speed
  - Maximum speed

### Compatibility

- Compatible with all HRV/ERV models.

### Electrical Diagram

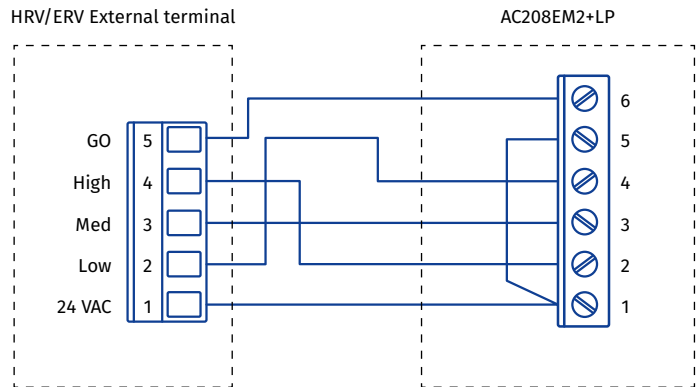



Blauberg North America  
1501 Veterans Memorial Pkwy E, Ste. 202,  
Lafayette, IN 47905  
tel.: 765 780 7139

[info@blauberg-na.com](mailto:info@blauberg-na.com)  
[blauberg-na.com](http://blauberg-na.com)