

VENTO EXPERT A50C3-1 S PRO



**Heat recovery
single-room units**

VENTO EXPERT

A50C3-1 S Pro

HEAT RECOVERY SINGLE-ROOM UNITS



up to
30 CFM



up to
93 %



from
0.3 Sones



FEATURES

Unique Single-Room Heat Recovery Ventilator

One Vento Expert unit in ventilation mode can serve rooms up to 500 sq. ft*

Communication between several ventilators for coordinated operation.

Efficient supply and exhaust single-room ventilation up to 30 CFM.

High-tech ceramic energy regenerator with max. heat recovery efficiency up to 93 %.

Integrated humidity sensor or connection to external sensor for comfortable microclimate.

Integrated control system.

Silent operation from 0.3 Sones.

Easy mounting and maintenance.

Air cleaning with total MERV 5 class filters.

Rated for continuous operation.

Frost- and condensate-free.

Design

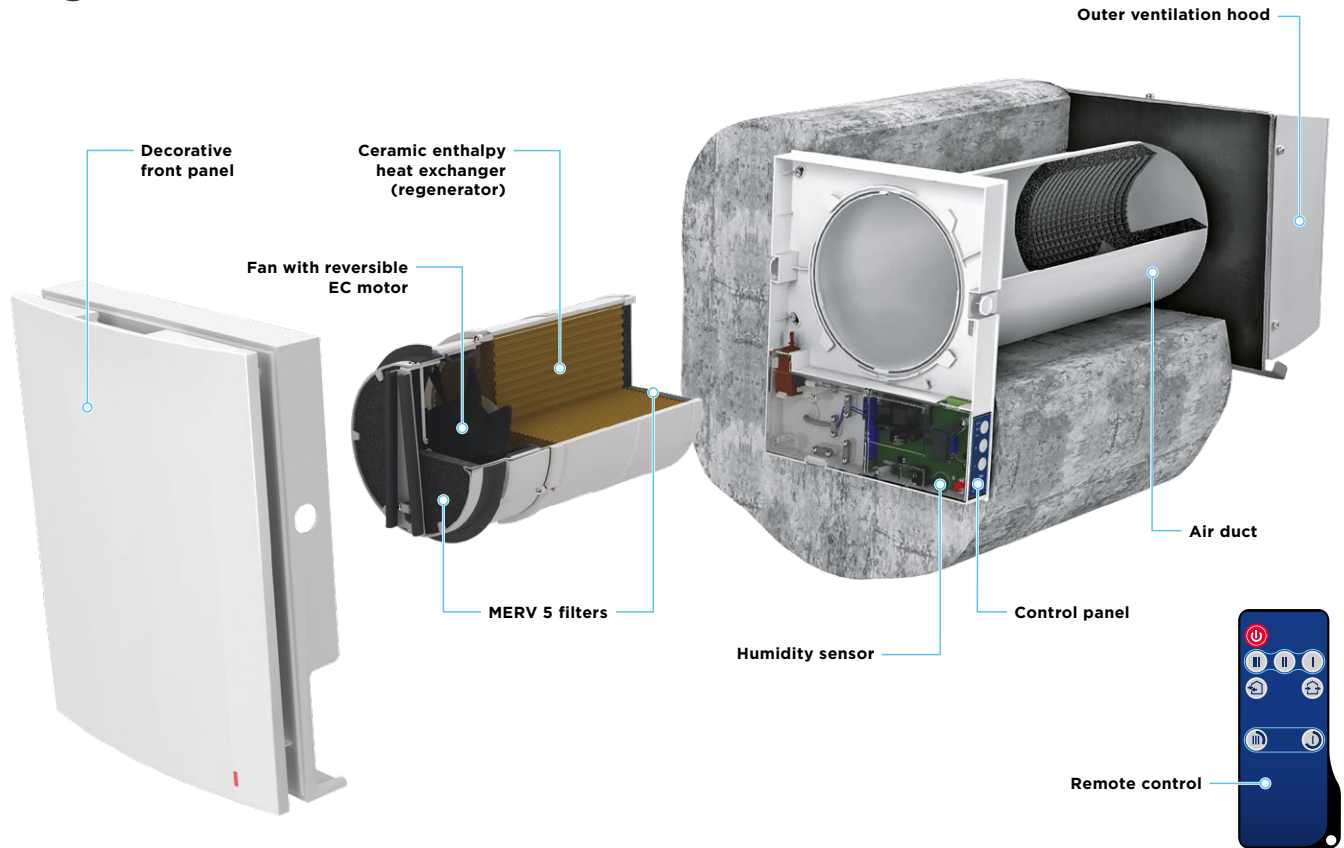

One of the best heat recovery efficiency on the market due to innovative hexagonal structure of the heat exchanger cells



Built-in Wi-Fi for wireless communication between units and Android or iOS device control

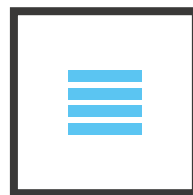

Integrated automatic air shutters prevent air back drafting



Easy maintenance. Indoor unit is opened by pressing the latches on both sides. The specially designed front panel can be closed manually to ensure air tightness and protect against wind impact

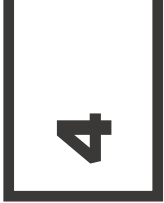

Energy Recovery



Warm stale air is extracted from the premise, flows through the ceramic regenerator and transfers its heat energy and moisture to it.

As the ceramic regenerator gets warmed up, the unit switches to the supply mode.

Clean cold intake air flows through the regenerator and absorbs accumulated heat and humidity.

When the ceramic regenerator is cooled down, the unit switches to the extract air mode.

Control

Control of the unit operation mode is performed by means of sensor control panel located on the unit casing or a remote controller.

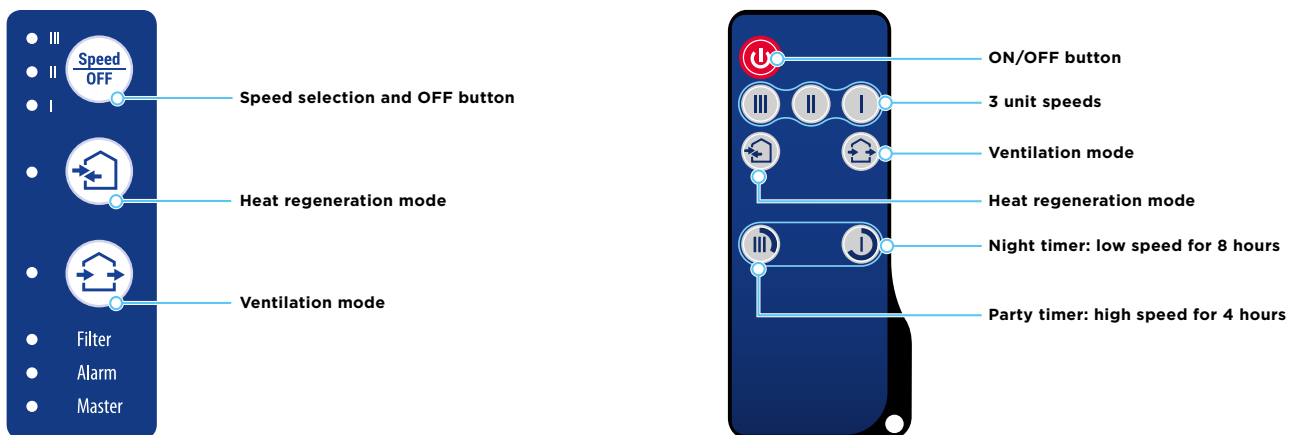

Vento Expert is equipped with a humidity sensor for indoor humidity control. If humidity increases above a set point, the unit boosts to the speed III.

Vento Expert either can operate as independent unit or can be connected with other units in a house and controlled with a primary unit. In this case, only the primary unit receives a signal from the remote control.

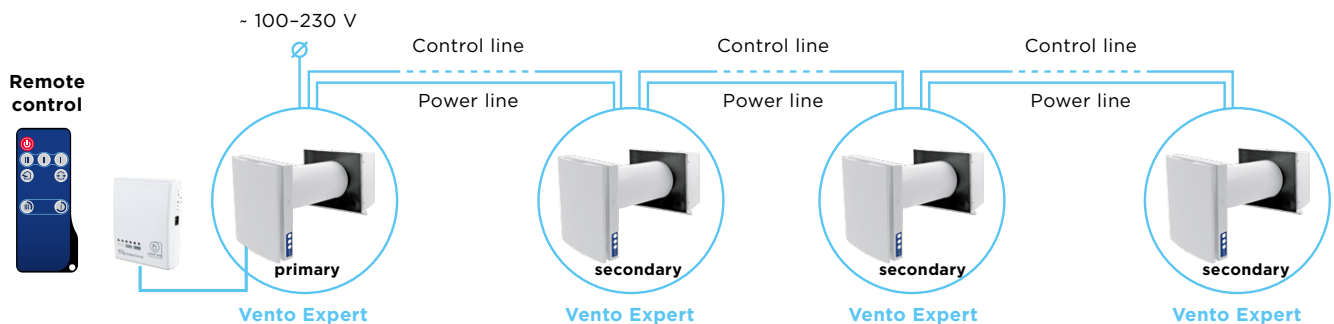

Mounting

The unit is designed for through-the-wall installation inside a prepared hole in an outer wall of the building.

The best ventilation solution is pairwise installation of reverse phase connected units. Some units ensure supply of fresh air to the room and the other units extract air from the premise. This way the most efficient balanced ventilation is arranged.

In case of brand new construction, units are mounted in two stages:

Pre-installation at the stage of the indoor finishing and outer decorative wall finishing. It includes installation of an air duct, an outer ventilation hood and cable installation.

Final mounting before commissioning of a house. It includes installation of a regenerator with a fan and filters and mounting and wiring of an indoor unit with a controller and shutters.

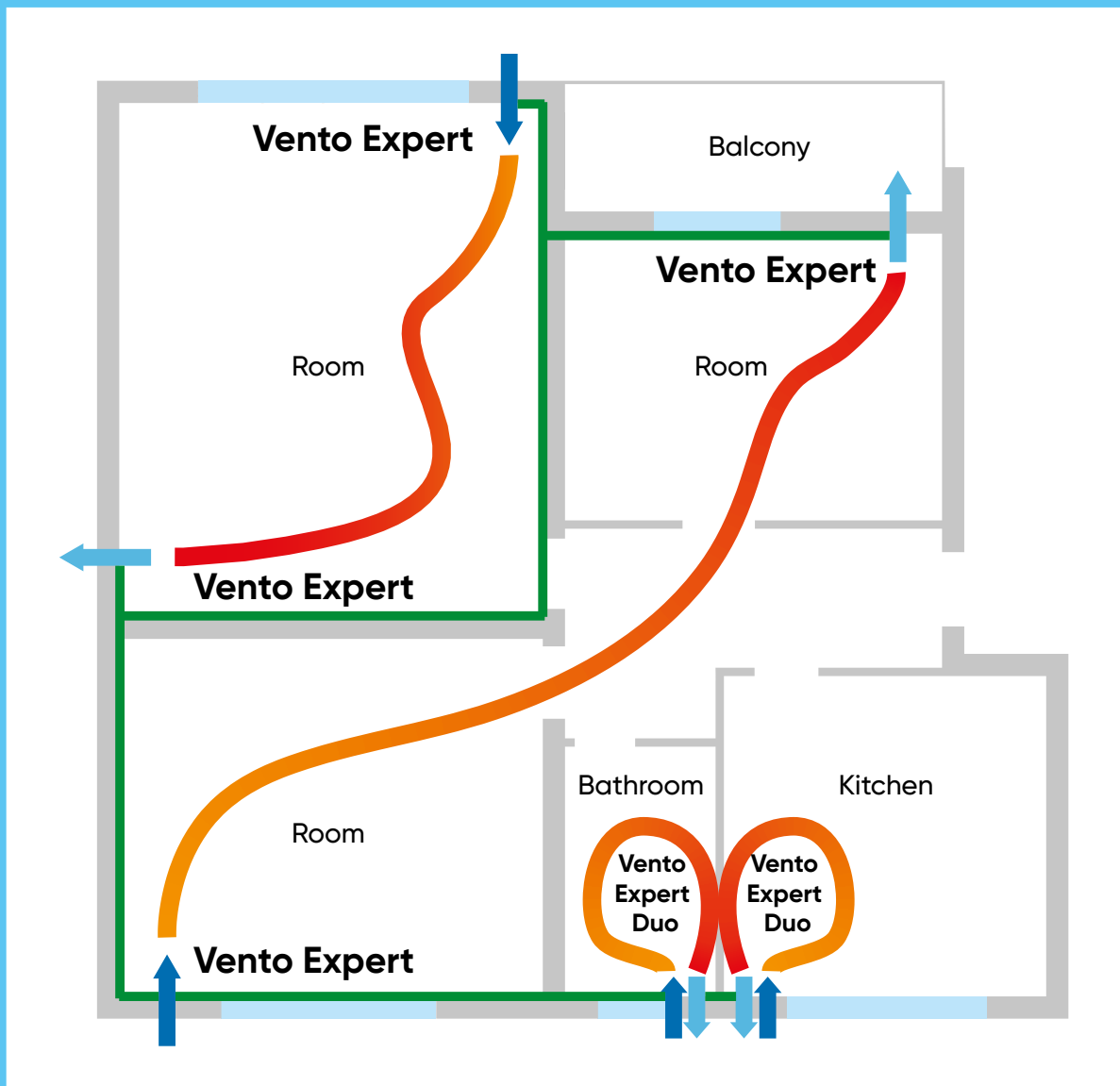

6



Technical data

Model	Vento Expert A50C3-1 S Pro		
Speed	1	2	3
Supply voltage, 50/60 Hz [V]	1-100-240		
Power [W]	4.45	5.08	7.06
Max. current consumption [A]	0.035	0.040	0.059
Air flow in ventilation mode [CFM]	9	18	30
Air flow in regeneration mode [CFM]	4	9	15
RPM	800	1300	1900
Sound [Sones]	0.6	1.0	1.4
Noise attenuation according to DIN EN ISO 10140-2: 2010 [Sones]	2.5		
Indoor/outdoor airtightness classification of the complete unit in accordance with EN 13141-8	D1		
Transported air temperature [°F (°C)]	-13...104 (-25...+40)		
Recovery efficiency [%]	≤ 93		
Ingress Protection	IP24		

Overall Dimensions [in (mm)]

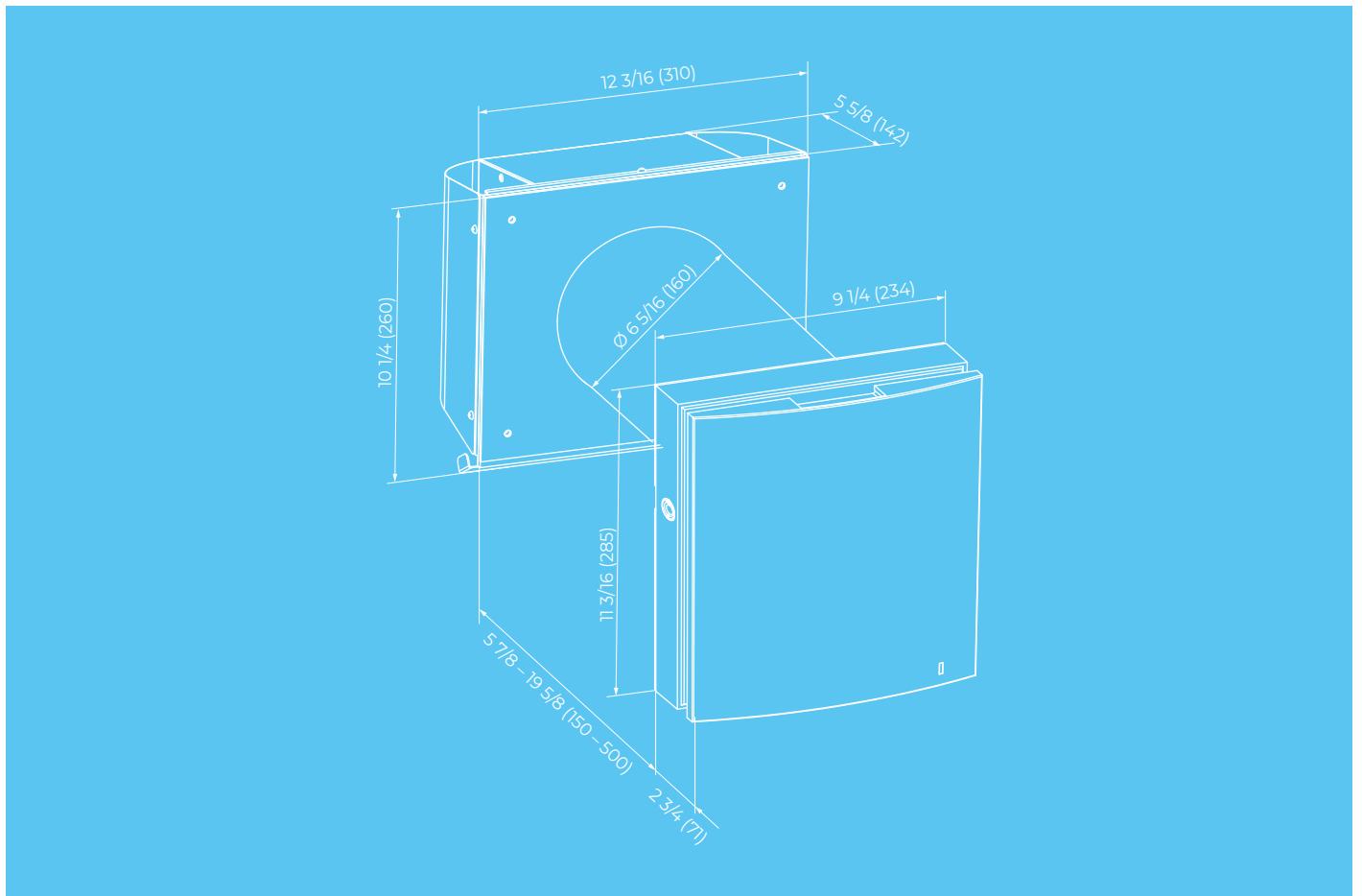



www.blauberg-na.com

Tel: (765) 780-7139
Fax: (661) 825-8895

1501 Veterans Memorial Pkwy E, Ste. 202,
Lafayette, IN, 47905
info@blauberg-na.com

Technical changes reserved.
Illustrations and texts are non-binding.

9|2024

